

Creda

HEATING

INSTRUCTION MANUAL

Installation and Operating

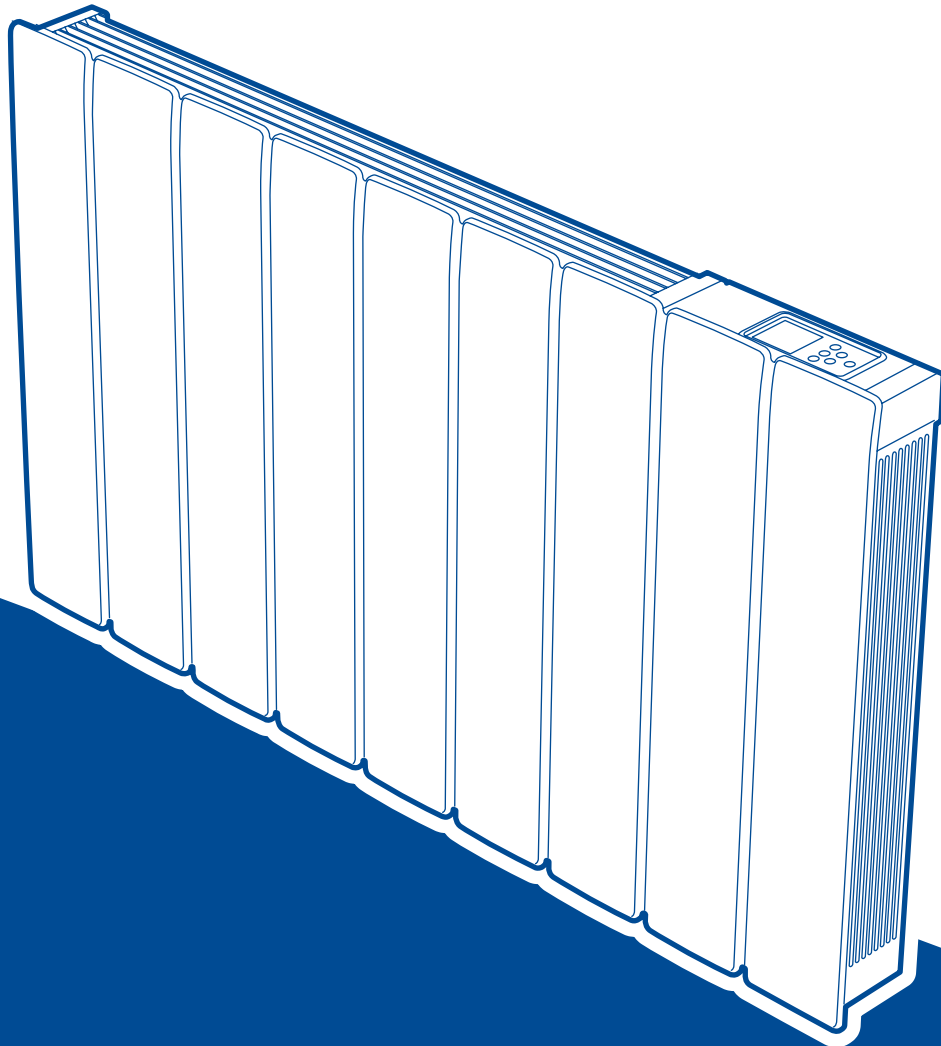

Creda CEPE Contour Panel Heater

Models: CEP050E / CEP075E / CEP100E / CEP150E / CEP200E

These instructions should be read carefully and retained for future use. Note also the information presented on the appliance.



IMPORTANT

THESE INSTRUCTIONS SHOULD BE READ CAREFULLY AND RETAINED FOR FUTURE REFERENCE. **Note also the information presented on the appliance**

CAUTION: FAILURE TO FOLLOW THESE INSTRUCTIONS MAY CAUSE INJURY AND/OR DAMAGE AND MAY INVALIDATE YOUR GUARANTEE

IMPORTANT SAFETY ADVICE

When using electrical heaters, basic precautions should always be followed to reduce the risk of fire, electrical shock, and injury to persons, including the following:

IMPORTANT – The wall bracket supplied with the heater must be used.

IMPORTANT – All packaging should be disposed of in an appropriate manner.

OVERHEATING WARNING

WARNING - In order to avoid overheating, do not cover or obstruct the heater. Do not place material or garments on the heater, or obstruct the air circulation around the heater, for instance by curtains or furniture, as this could cause overheating and a fire risk. NEVER cover or obstruct in any way the heat outlet slots at the top of the heater or the air inlet slots in the base of the heater.

WARNING - THE SURFACES ON THIS HEATER CAN BE HOT. The heater carries a warning 'DO NOT COVER' to alert the user to the risk of fire that exists if the heater is accidentally covered.

CAUTION - Some parts of this product can become very hot and cause burns. Particular attention has to be given where children and vulnerable people are present.

For your safety this heater is fitted with a thermal cut-out. In the event that the product overheats for some reason, the cut-out prevents excessive temperatures on the product by cutting the power to the heater. Once the heater has cooled down, it will reset automatically, it will continue to cycle on and off automatically until the reason for overheating is removed. The display screen may flash red to indicate the product has overheated. To reset the display, remove the obstruction and hold Enter for 10 seconds.

SUITABLE APPLICATIONS

WARNING - This heater is suitable for normal domestic household purposes and should not be used in any other type of environment. This product should only be used in the country where it was purchased from by a recognised commercial retailer. **Do not use outdoors. Do not install if the product is damaged.**

SERVICING AND REPAIRS

WARNING - Servicing and product repairs should only be undertaken by the manufacturers approved service agent or a similarly trained or qualified person, using only exact manufacturer approved spare parts.

PLEASE NOTE: Household dust, lit cigarettes, candles and oil burners, combined with the convection effect of electric heaters can cause significant soot deposits to build up on the surface directly above and to the sides of the heater. This is not a fault of the heater. Extensive burning of candles or smoking in the operating environment of this product can produce heavy discolouration within a few months of use.

OPERATING WARNINGS

IMPORTANT: Remember to observe all safety warnings and precautions when operating the heater on the automatic or timer modes, either attended or unattended since a fire risk exists when the heater is accidentally covered or displaced.

CAUTION: Do not use if the heater's mains power lead is damaged. If the supply cord is damaged it must be replaced by the installer or an approved Dimplex service partner.

ELECTRICAL INSTALLATION

WARNING - The electrical installation of this heater must be carried out by a suitably qualified or trained electrician, and be in strict accordance with the current wiring Regulations BS 7671. The supply must be connected via a switched fused spur with a fuse rated suitably for the appliances flex. Failure to follow these instructions will mean that the manufacturer's instructions have not been adhered to. **THERE ARE NO EXCEPTIONS.**

WARNING - Minimum clearances and IP zone requirements must be adhered to in accordance with the current wiring regulations. The wires in this mains lead are coloured in accordance with the following code:

GREEN AND YELLOW: EARTH

BLUE: NEUTRAL

BROWN: LIVE

- This heater must be earthed
- Not suitable for connection via a plug top
- Do not locate the heater immediately below a fixed electrical point i.e. socket outlet.

The heater is fitted with a length of flexible cable type H05VV-F size 3 x 1.0mm² for 500W to 2kW models for connection to the fixed wiring of the premises through a suitable connection box positioned adjacent to the heater. A means for disconnection must be incorporated in the fixed wiring of the premises in accordance with the current wiring regulations. The supply circuit to the heater must incorporate a double pole isolating switch having a contact separation of at least 3mm. Products that are supplied without a plug are for installation into the fixed wiring of the property, via a suitable double pole switched fused spur with a fuse rated suitably for the appliances flex. Typical fuse ratings for 230V equipment - Up to 700W = 3A, over 700W = 13A.

In installation the supply cord may be cut to the appropriate length for the electrical connection point. Excess cable should not be inserted and stored behind the heater.

WARNING: This heater must not be connected to the electricity supply via an external switching device (such as a timer) or a circuit that is regularly switched on and off by the utility supplier. Failure to follow this warning could result in the heater's thermal cut-off being inadvertently reset and could create a fire hazard. Cables/flexes that are supplied pre-fitted to the product must NOT be extended.

CHILD SAFETY

WARNING - This appliance is not intended for use by persons (including children) with reduced physical, sensory or mental capabilities, or lack of experience and knowledge, unless they have been given supervision or instruction concerning use of appliance by a person responsible for their safety.

This appliance can be used by children from 8 years and above and persons with reduced physical, sensory or mental capabilities or lack of experience and knowledge if they have been given supervision or instruction concerning use of the appliance. Children shall not play with the appliance. Cleaning and user maintenance shall not be made by children without supervision. Children of less than 3 years should be kept away unless continuously supervised.

Children aged from 3 years and less than 8 years shall only switch on/off the appliance provided that it has been placed or installed in its intended normal operating position and they have been given supervision or instruction concerning use of the appliance in a safe way and understand the hazards involved. Children aged from 3 years and less than 8 years shall not regulate and clean the appliance or perform user maintenance. This product contains a replaceable battery. **WARNING - KEEP BATTERIES OUT OF REACH OF CHILDREN.**

WARNING - Packaging should be disposed off responsibly as the EPS used could be a potential choking hazard for children.

Energy Related Product Directive

This product complies with Lot20 of the Energy Efficiency Directive (2015/1188).

Type of heat output/ room temperature control

With electronic room temperature control	Yes
Electronic room temperature control plus week timer	Yes
With open window detection	Yes
With adaptive start control	Yes

Technical Details

Model Identifier(s):		CEP 050E	CEP 075E	CEP 100E	CEP 150E	CEP 200E
Nominal heat output	P _{nom}	0.5 kW	0.75 kW	1 kW	1.5 kW	2 kW
Height (mm)		536	536	536	536	536
Width (mm)		503	503	617	741	911
Depth (mm)		104	104	104	104	104
Minimum heat output (indicative)	P _{min}	N.A.	N.A.	N.A.	N.A.	N.A.
Maximum continuous heat output	P _{max,c}	0.5	0.75	1	1.5	2
Auxiliary electricity Consumption						
At nominal heat output	e _{lmax}	0.00	0.00	0.00	0.00	0.00
At minimum heat output	e _{lmin}	0.00	0.00	0.00	0.00	0.00
In standby mode	e _{lSB}	<0.0005	<0.0005	<0.0005	<0.0005	<0.0005
With open window detection		Yes				
With adaptive start control		Yes				

All Models	
Controls	Digitally controlled, Electronic Thermostat accurate to ($\pm 0.2^{\circ}\text{C}$) Timer modes: 7 Day Programmable User Timer Continuous heat modes: Manual, Frost Protect, Off, Setback Mode
Controller UI	<ul style="list-style-type: none"> •Icon-based display with white backlight •Capacitive buttons with audio feedback •User replaceable battery (Coin-Type)
Controller Functions	<ul style="list-style-type: none"> •Open window detection, Adaptive-start, •Advance time period •Adjustable max SP range ($7\text{-}32^{\circ}\text{C}$) •Bluetooth for software updates •Child Lock
Construction	<ul style="list-style-type: none"> •Durable epoxy-polyester powder coated steel casing with slotted upward facing grille •Advanced controls with cap-sense technology for total flexibility of heating
Element	Compact, finned, mineral filled sheathed element
Battery	3.3V coin cell battery, type CR2032, $T_{85^{\circ}\text{C}}$, to backup real time clock. Battery life >5 years.
Installation	1 H-frame wall bracket for easy fixing
Safety	<ul style="list-style-type: none"> •Thermal cut-out. Auto reset type •Overheat detection
IP Rating	IP24
Battery	3.3V coin cell battery to backup real time clock. Battery life >5 years.
Supply	1.3 metres fitted, 3 core for fused spur installation, 1/N/PE $\sim 230\text{-}240\text{ V}$, 50Hz Class I, with earth wire
Colour / Finish	Metal Chassis, Air Outlet Grille & Control Moulding - Traffic White (RAL 9016)

General Information

Please read the instructions closely before first using the product. There is also a quick-start guide on the page 8 if you need a reminder of how to use the basic functions in the future.

The heater is designed for wall mounting using the wall bracket supplied. It should only be operated when in the upright position as shown - see **Fig.3** and **Fig.4**. All models are splash proof to IP24. Before connecting the heater check that the supply voltage is the same as that stated on the heater.

Wall Mounting Instructions

IMPORTANT - The wall bracket supplied with the heater must be used and the heater must be installed in the correct orientation. The fixings should be used to secure the bracket to the particular wall on which the heater will be installed. The heater should be positioned observing the minimum clearances stated around the heater - see **Fig. 1**, **Fig. 3** and **Fig. 4**.

MODEL	A	B	C	D	E
CEP050E	390mm	150mm	503mm	536mm	104mm
CEP075E	390mm	150mm	503mm	536mm	104mm
CEP100E	560mm	150mm	671mm	536mm	104mm
CEP150E	630mm	150mm	741mm	536mm	104mm
CEP200E	800mm	150mm	911mm	536mm	104mm

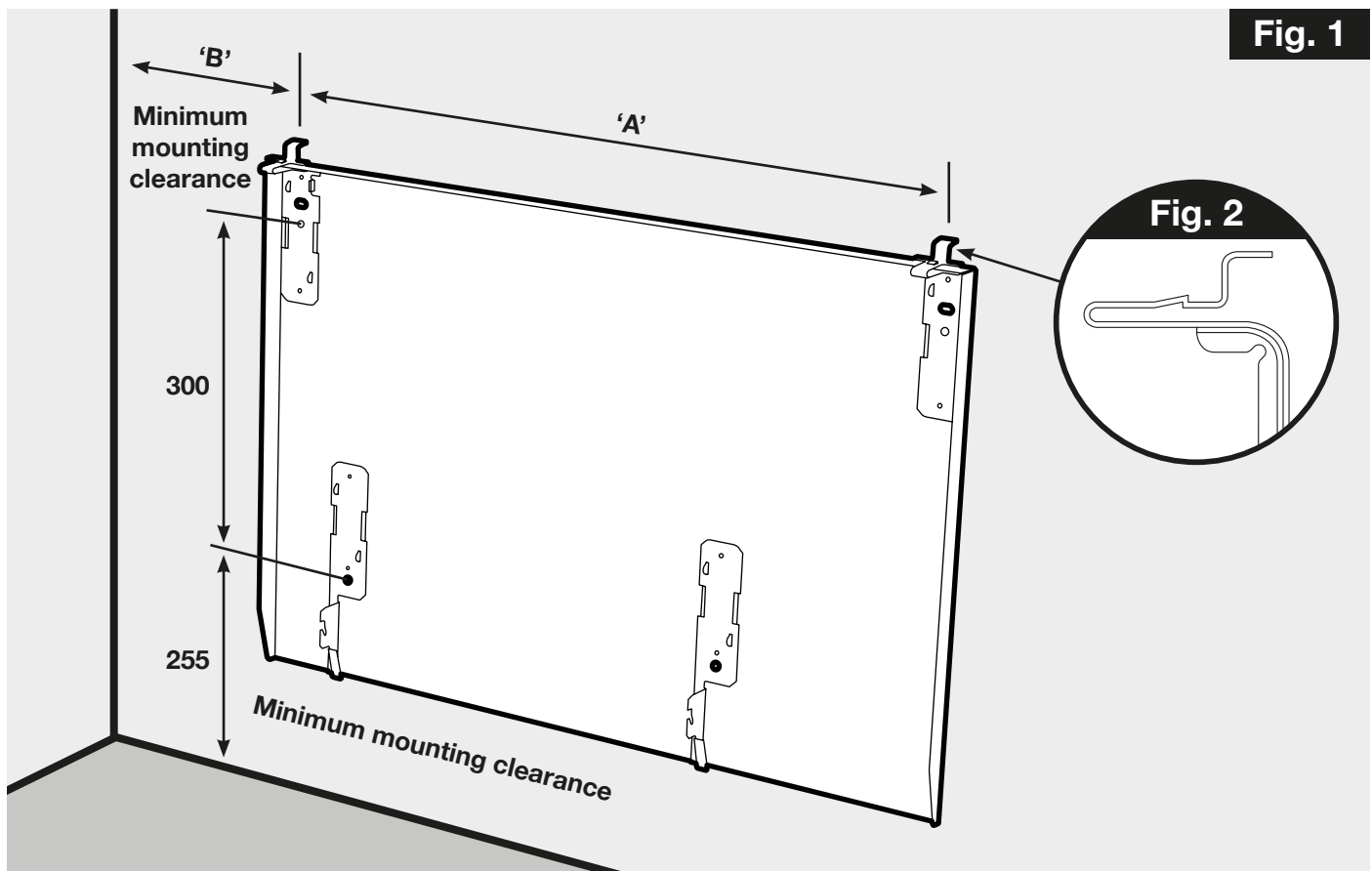

To mount the heater to the wall:

1. Remove wall mounting bracket from the back of the heater by depressing the spring latch at the side of each bracket - see Fig.2.
2. Fix the wall bracket securely to the wall through the four screw holes. Ensure only screw fittings provided are used for the particular wall type.
3. Present the heater to the wall bracket and engage bottom slots in the back with bracket hooks.
4. Press heater into locked position and ensure the clips on the top are engaged.

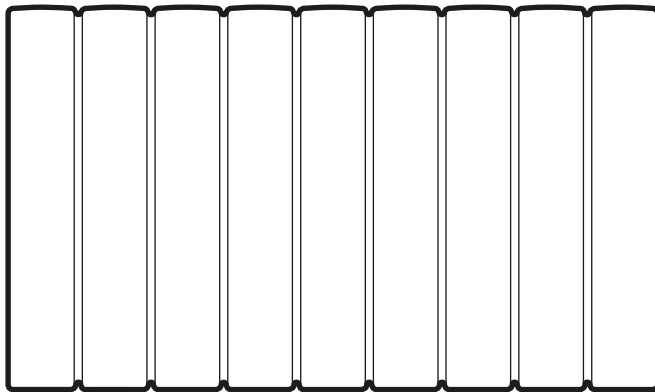

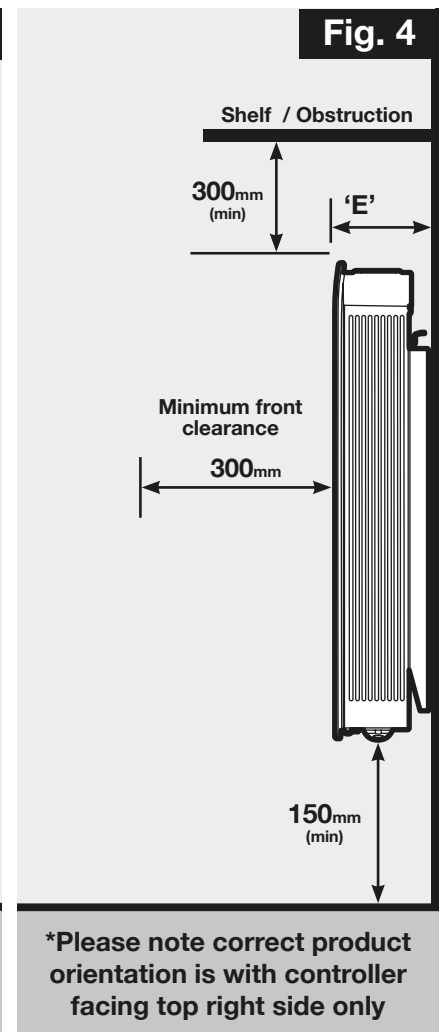
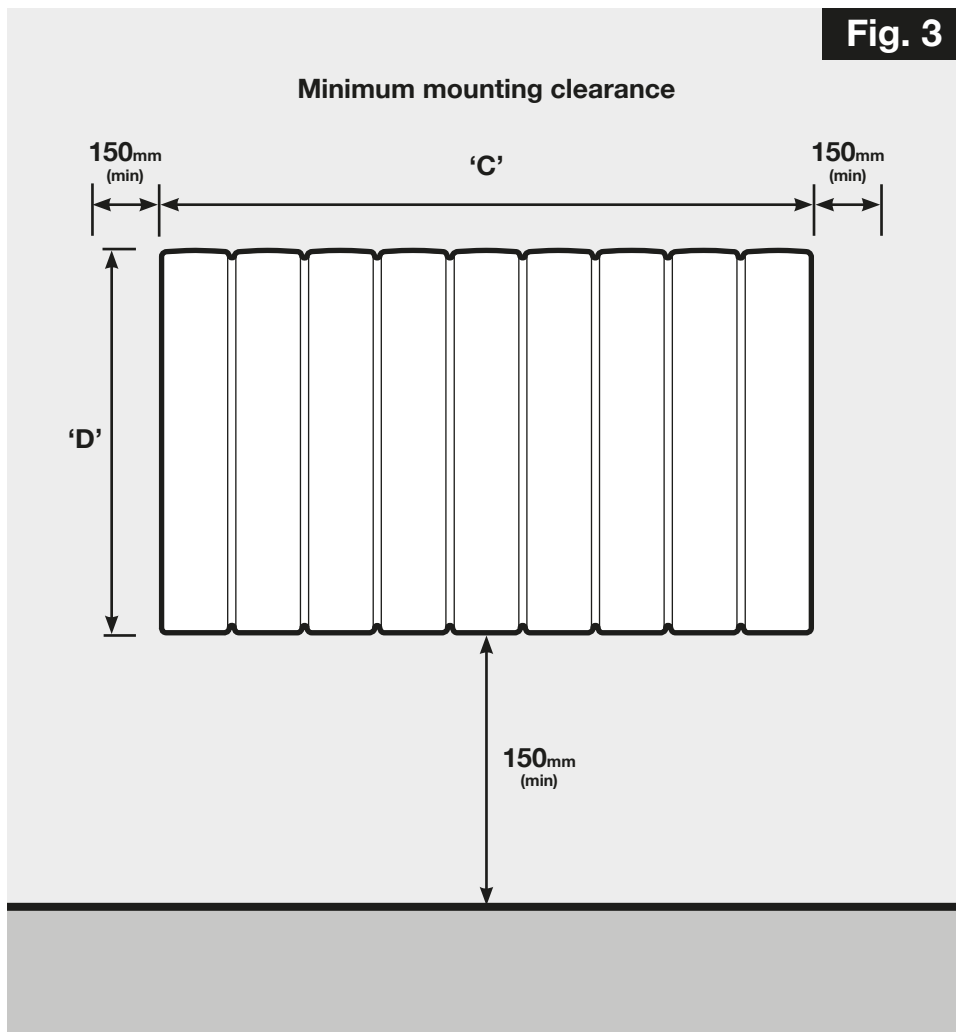

WARNING:
This product is heavy and care should be taken in installation



Quick Start Guide

How does the heater control work?

The control allows you to choose when you want heat and at what temperature. When using a timer mode (see below) **ON** will display on the home screen to tell you when the heater is maintaining the temperature displayed. The current time will be displayed when the heater is outside of a timed heating period.

When  **Manual**,  **Schedule** or  **Frost** modes are being used the heater will always maintain the temperature shown on the home screen.

Set the Time

To set the date and time on the heater, press **Menu**, then press **Up** three times to highlight the  **Date & time** icon, press **Enter**. Use the **Down** and **Up** to increase/decrease the hour, press **Enter** to confirm. Repeat this process to set the minutes, Day, Month and Year. Press **Enter** to confirm and return to home screen.

Set the Temperature

The temperature shown on the display is the target room temperature known as Setpoint. This is the temperature that the heater will maintain during the heating periods. If the room temperature is above this temperature then the heater will not operate. The heater leaves the factory with this temperature set at 21°C which represents a typical comfortable room temperature. If you require a different room temperature then press either **Down** or **Up** until the display shows the temperature you require

Your heater comes pre-programmed with four heating periods. These periods set the time and temperature at which the heater operates in Comfort ON mode. These four periods are:

- P1: 07:00 – 09:00 21°C
- P2: 10:00 – 12:00 7°C
- P3: 13:00 – 15:00 7°C
- P4: 17:00 – 21:00 21°C

Child Lock

If you need to lock the controls so that the settings cannot be changed then activate the Child Lock. To lock the controls press and hold both the **Back** button and **Enter** button together for **3 seconds**. The  Lock icon will appear on the screen. To unlock repeat the action by pressing both the **Back** button and **Enter** for three seconds.

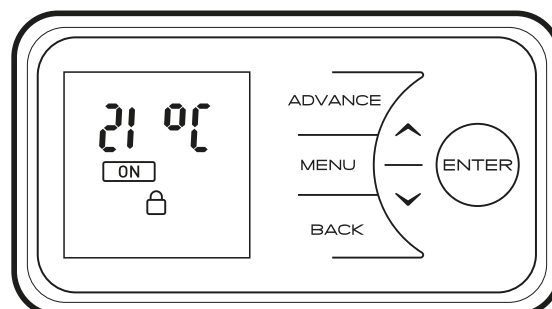

The controls are located on the top of the heater. The heater is fitted with an adjustable electronic controller consisting of a display screen and six touch sensitive buttons.

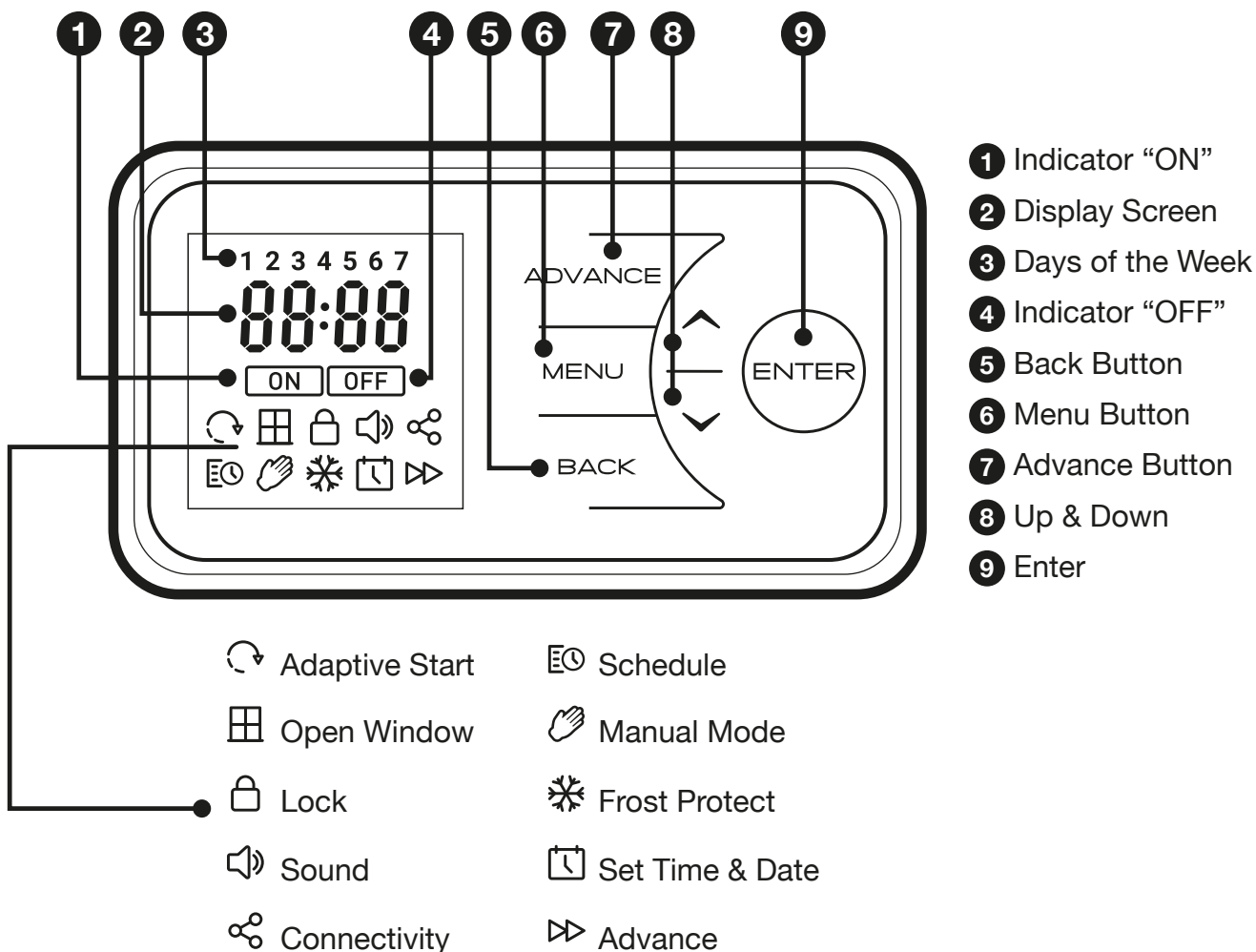

The heater is fitted with an adjustable thermostat enabling the room temperature to be controlled. The minimum room temperature is 7°C. The maximum temperature is set to 26°C by default, however, this can be increased to 32°C if required. A temperature of 21°C would be comfortable for most people.

Note: Your heater may produce some noise during operation. This noise is caused by the expansion and contraction of the element as it changes temperature, and is normal for this type of product. Whilst the noise produced is usually very quiet, certain environmental factors can make it more noticeable, such as hard flooring or minimal furnishings.

Note: Should the heater fail to operate, this may be due to the room temperature being higher than the thermostat setting.

Control Functions

The heater controls can be easily adjusted by using the six buttons on the user interface.

1. The Display **Screen** shows the options available at each stage of adjustment
2. **Menu** - displays the main options list
 - 🕒 **Schedule**: Set the program times and temperatures
 - 👉 **Manual Mode**: Toggle between Manual / Standby
 - ❄️ **Frost Protect**: Set the frost protect temperature
 - 📅 **Set Time & Date**: Set the Date and Time
3. **Back** returns to the previous programming stage
4. The **UP** and **DOWN** buttons are used to navigate through the menus and alter setting values. The **UP** and **DOWN** buttons are also used to adjust the required room temperature on the main screen.
5. **Enter** is used within the menu options to confirm settings. On the main screen pressing **Enter** will display the Device Name as a 4 digit PIN. The timed periods during which the heater is providing heat are defined as Comfort On (this is displayed in the middle of the screen). Outside of heating periods the heater will not deliver heat and these periods are called **Comfort Off**. While constant heat modes are active, the mode of operation is displayed at the bottom of the screen e.g. **Manual** 👉
6. The **Advance** button overrides the heating settings and changes the operational state of the heater. When a timer has been selected, the **Advance** function allows you to begin the next period early. If the heater is in a **Comfort Off** period and you want heat - press the **Advance** button. If the heater is in **Comfort On** and you don't want heat, press the **Advance** button and it will go off until the beginning of the next **Comfort On** Period.

If the heater is in a constant mode of operation, **Advance** can be used to switch the heater on and off.

Main Screen

After 30 seconds the heater will default back to the Main Screen. Here the chosen temperature is displayed along with the mode of operation. Any use of the **Advance** function will be displayed here.

When left inactive for a long period of time this display will “sleep” and the text will disappear. Press any button for its return.

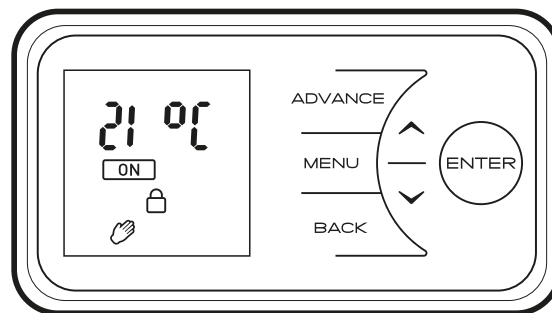

NOTE:

Pressing **Enter** will show the Device Name as a 4 digit PIN



NOTE:

The display screen will return to the main screen after a period of 30 seconds inactivity

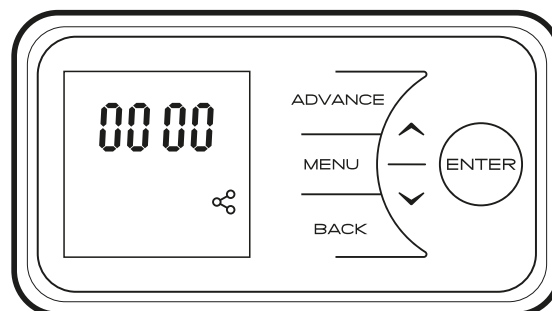

Setting the Date and Time

The heater incorporates a real time clock with calendar function. The clock has a battery backup that will keep the clock running in the event of a mains power outage.

To adjust the date and time follow the steps below

- Press the **Menu** button
- Press **Up** button 3 times
- Press **Enter** when the  **Date & time Icon** is highlighted
- Press **Enter** to set Time
- Press **Down / Up** to set the Hour, then press **Enter** to confirm
- Press **Down / Up** to set the Minutes, then press **Enter** to confirm
- Press **Down / Up** to set the Day, then press **Enter** to confirm
- Press **Down / Up** to set the Month, then press **Enter** to confirm
- Press **Down / Up** to set the Year, then press **Enter** to confirm

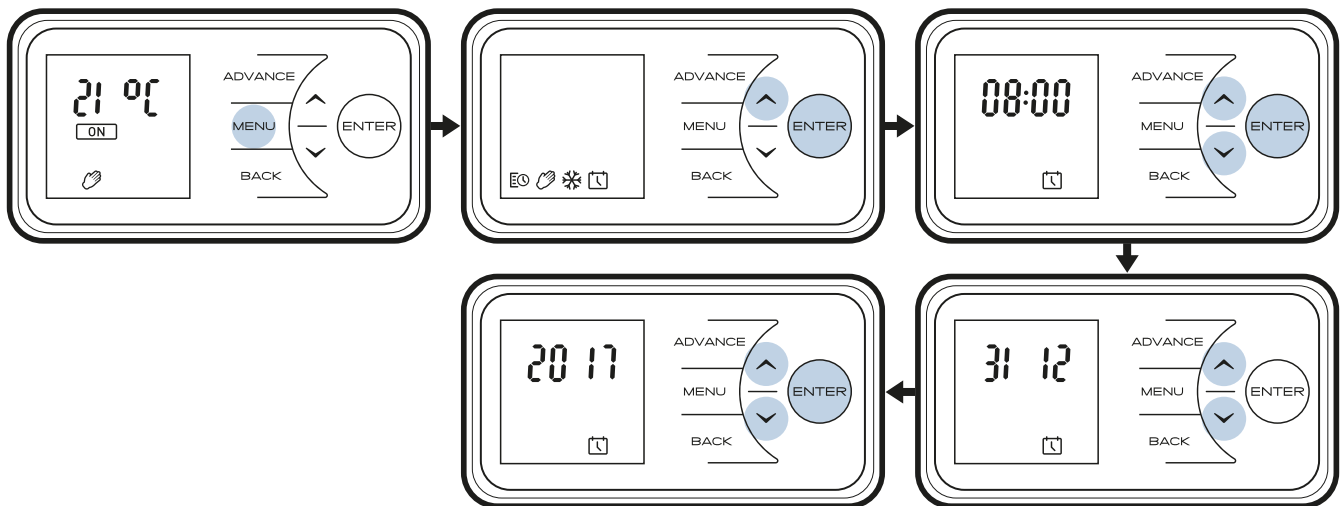

Mode of Operation

User Timer

Provides greatest flexibility to the user. Four time slots are available throughout the day and these can be customised for each day of the week. See 'Setting a Timer' on page 14 for instructions on adjusting these from the factory default time periods & temperatures.

The heater can also maintain a constant room temperature using the following modes:

 **Manual Mode** - Heats the room to a comfortable temperature of 21°C.

 **Frost Protect** - Maintains a room temperature of 7°C. This mode should be used to provide protection against frost as indicated by the  Frost icon.

Standby - Select **Standby** to switch off the heating element. Heat will not be provided. To activate standby:

- Press **Menu** button
- Press **Up** highlight the hand icon .
- Press **Enter**
- Toggle to Off



NOTE:

*In all modes **Down** and **Up** can be used to adjust the required room temperature. In timer mode, this change is temporary and the heater will set the room temperature based on the saved heating profiles.*



NOTE:

It is recommended that the timer mode is used as doing so can reduce the running cost. Operating the appliance in the permanent heating modes may result in increased running costs.

Selecting a Timer Mode

User Timer - To activate **User timer** mode:

- Press **Menu** Button
- When the **ECO Schedule Icon** is highlighted Press **Enter**
- With **ON** highlighted press the **Enter** Button to activate User Timer, the backlight will flash and the screen will return to the home screen.

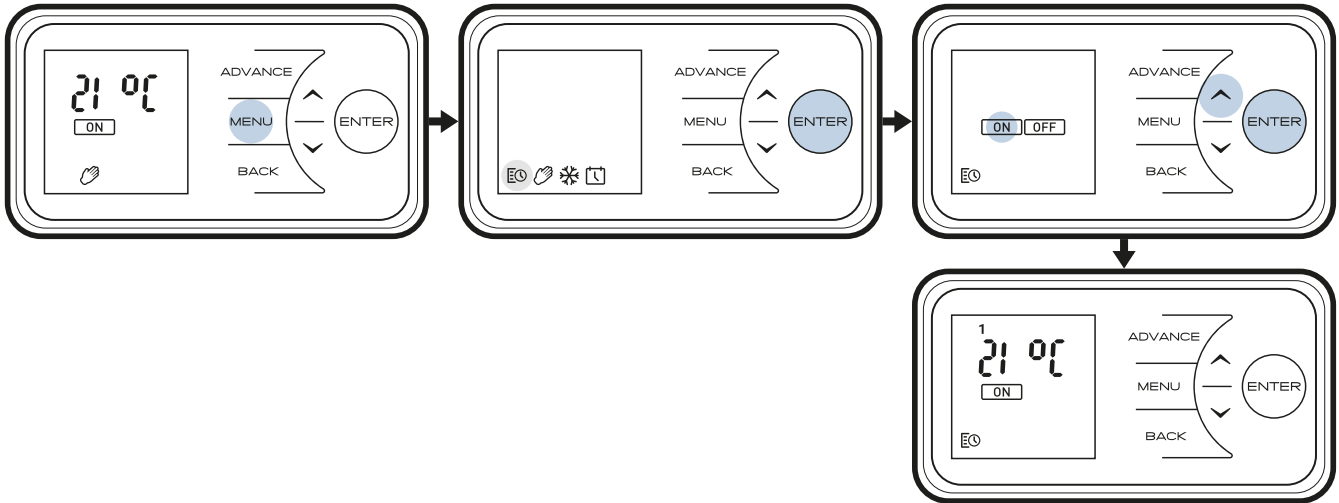

Setting a Timer

User Timer - To re-programme the factory default Timer Modes:

- Press **Menu** Button
- When the **ECO Schedule Icon** is highlighted Press **Enter**
- Press **Up** twice then press **Enter**

Days of the week are now displayed at the top of the screen

- Day 1 = Monday
- Day 2 = Tuesday
- Day 3 = Wednesday
- Day 4 = Thursday
- Day 5 = Friday
- Day 6 = Saturday
- Day 7 = Sunday

- Press **Enter** to Modify Day 1 or Press **Up** to navigate to the desired day and Press **Enter** to Select

1. P1 will be displayed on screen
2. Press **Enter** to select P1, to navigate to P2, P3 or P4 press **Up** and press **Enter** to select
3. **ON** will be highlighted, press **Enter** to set the on Time
4. Press **Down** or **Up** to adjust the on Hour time, press **Enter** to Confirm
5. Press **Down** or **Up** to adjust the on Minute time, press **Enter** to Confirm
6. Press **Down** or **Up** to adjust the Temperature setting, press **Enter** to Confirm
7. Press **Down** or **Up** to adjust the off Hour time, press **Enter** to Confirm
8. Press **Down** or **Up** to adjust the off Minute time, press **Enter** to Confirm

Press **Enter** to modify Programme P2, follow steps 1-8, Press **Up** to skip to P3
 Press **Enter** to modify Programme P3, follow steps 1-8, Press **Up** to Skip to P4
 Press **Enter** to modify Programme P4, follow steps 1-8

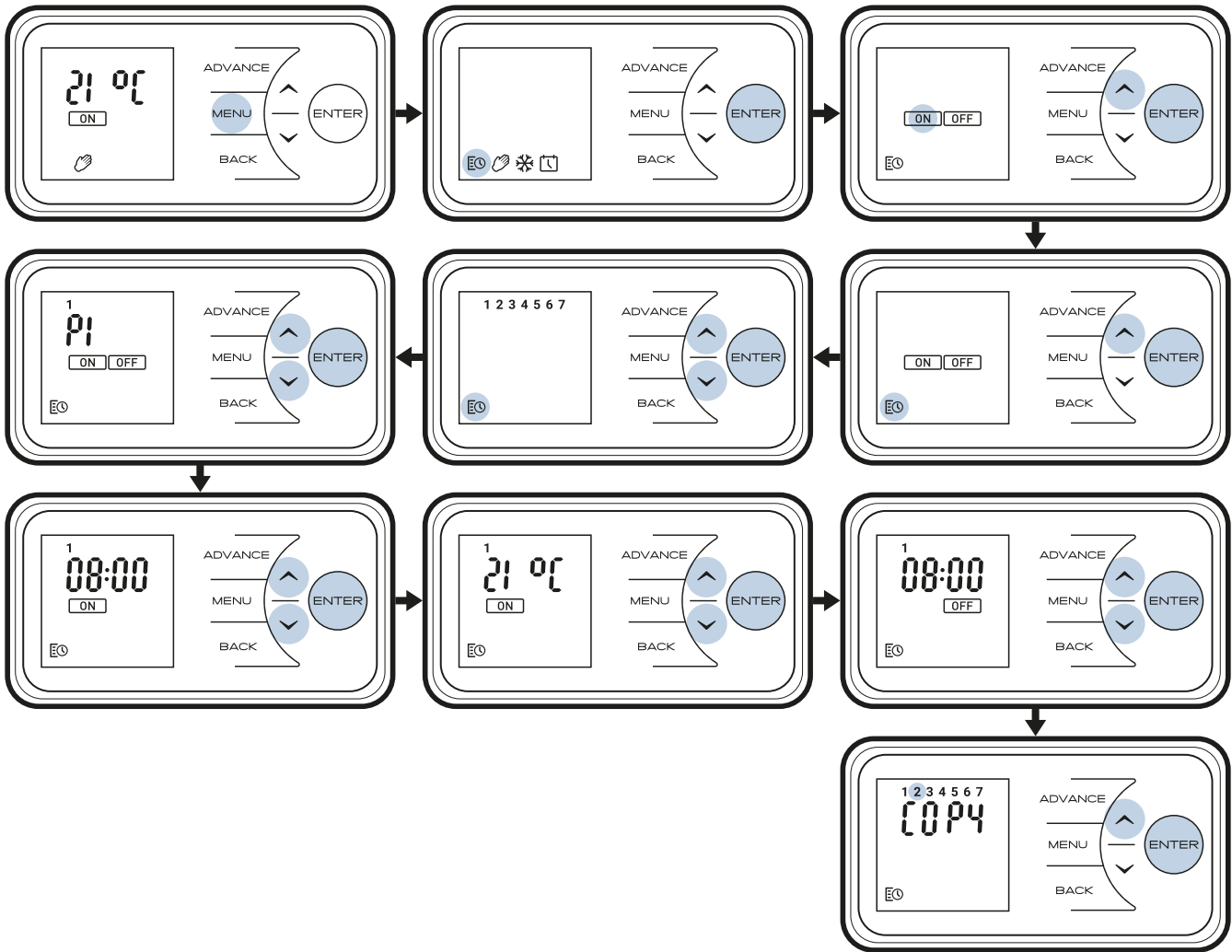

Once P1-P4 heating programmes have been set, **COPY** will flash on the screen. To copy newly programmed P1-P4 heating programmes to other days press the **Enter** button.

COPY will be displayed on screen and the next day in sequence will flash at the top of the screen, To copy to the next day in the sequence, press **Up** button, to deselect the next day in sequence press **Enter** button.

The days of the week that are selected will be displayed at the top of the screen. The days that have been deselected will not be visible (see Diagrams).



Press **Enter** to confirm, backlight will flash and return to the User Timer screen. With **ON** highlighted press the **Enter** Button to activate User Timer, the backlight will flash and the screen will return to the home screen.

Setting Modes

 **Manual Mode** - To choose a constant heat mode. This mode ignores the User Timer and maintains the displayed temperature.

- Press **Menu** Button
- Press **Up** to highlight the Hand icon
- Press **Enter** Button
- Ensure **ON** is highlighted
- Press **Enter** Button
- Use **Down** and **Up** to adjust to the desired temperature
- Press **Enter** to Confirm

 **Frost protect** - Frost protect mode maintains a room temperature of 7°C throughout a 24 hour period. This mode should be used to provide protection against frost as indicated by the Frost icon.

- Press the **Menu** button
- Press **Up** twice to highlight the snowflake icon
- Press Enter to access the  Frost protect menu
- Press **Down** or **Up** to adjust the  Frost protect temperature setting
- Press Enter to confirm

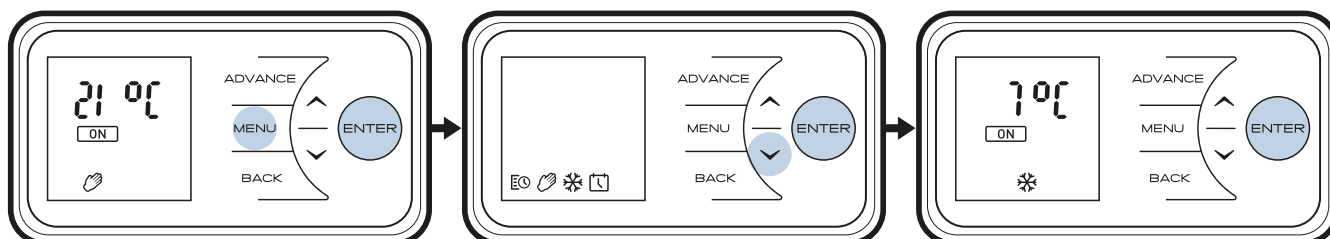

Standby - Select **standby** to switch off the heating element. Heat will not be provided.

To activate standby:

- Press **Menu** button
- Press **Up** to highlight the Hand icon
- Toggle to Off
- Press **Enter** to confirm

The screen will appear blank

Advance

Sometimes you may be at home when you had not planned to be or need to leave when you had planned to have heating on. You can change the way you use your heating temporarily; this temporary change is achieved using the **Advance** function.

When a timer has been selected, the **Advance** function allows you to begin the next period early. If the heater is in a **Comfort Off** period and you want heat - press the **Advance** button. The **Advance** icon \gg will be displayed on the screen. If the heater is in the **Comfort On** and you don't want heat, press the **Advance** button and it will go off until the beginning of the next **Comfort On** Period.

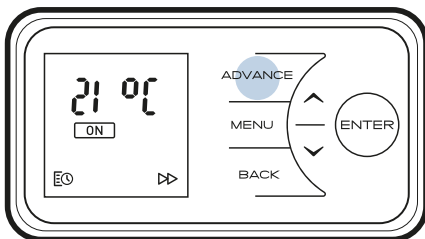

Options

DST Rule - Select your daylight saving setting. The heater clock will automatically adjust for daylight saving time. If no adjustment is required then select off.

- Press the **Menu** button
- Press **Up** button 3 times
- Press **Enter** when the  **Date & time Icon** is highlighted
- Press **Down** or **Up** to **Enter** DST screen
- Press **Enter** to adjust DST
- Press **Down** or **Up** to toggle DST on/off
- Press **Enter** to confirm

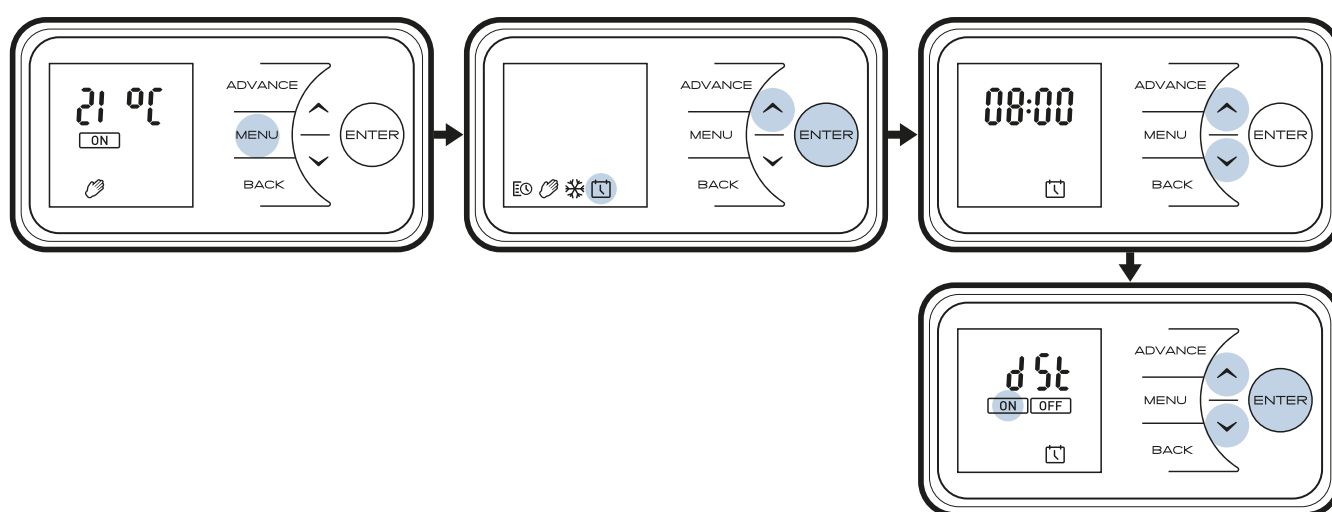

Sound - Audio feedback can be enabled or disabled.

- Press the **Menu**, **Back** and **Enter** buttons and hold for 10 seconds
- Press **Up** button 2 times
- Press **Enter** when the Sound Icon is highlighted
- Press **Down** or **Up** to toggle audio feedback on/off
- Press **Enter** to confirm

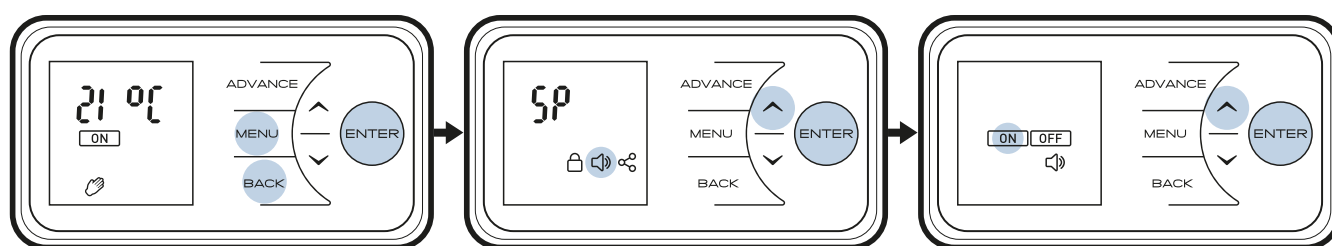

Comms - Choose to enable or disable Bluetooth pairing function. Bluetooth is disabled by default.

Bluetooth

- Press the **Menu**, **Back** and **Enter** buttons and hold for 10 seconds
- The Setpoint menu will be displayed.
- Press **Up** 3 times to highlight the Comms icon
- Press **Enter** to enter the Comms menu
- Press **Enter** to access the Bluetooth (BT) menu
- Press **Down** or **Up** to toggle Bluetooth on/off
- For Bluetooth on, highlight **ON** and press **Enter** button
- Home screen will now display coms icon.

When pairing with a mobile device the 6 digit pairing code will display on the screen automatically. Initially the first three digits (example: -000) will be displayed. Use the up/down arrow keys to display the next three (example: 000-).

- Confirmation screen will show Bluetooth pairing code, Comms symbol will flash while “advertising” Bluetooth. Enter this code to mobile device.
- Press **Enter** to confirm

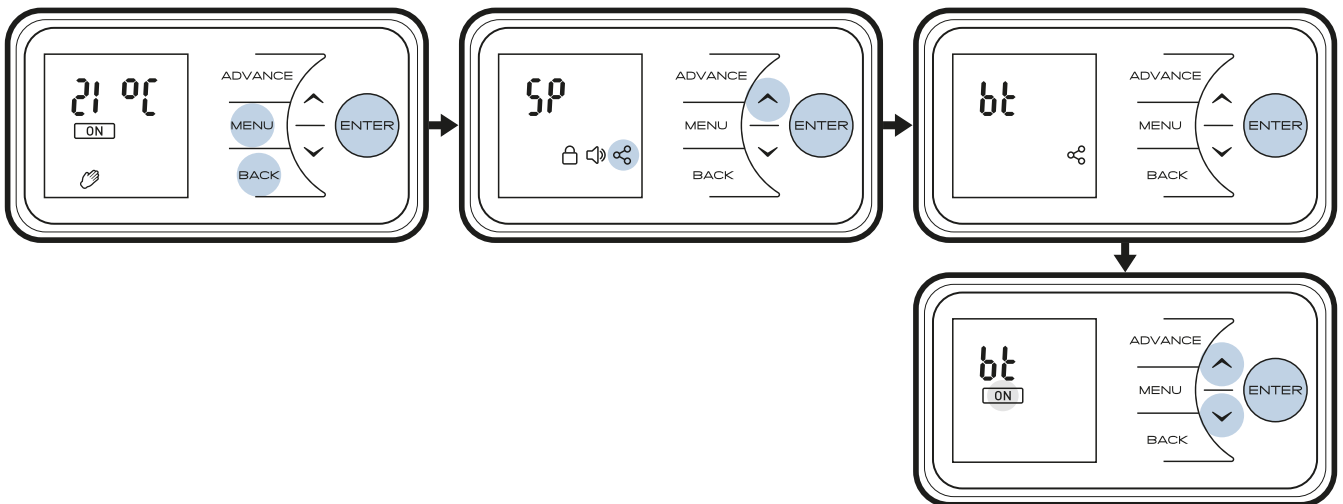

Child Lock

To Lock the controls press **Back** and **Enter** together for 3 seconds. The  Lock icon will appear on the screen. To unlock the control, repeat the action of **Back** and **Enter** together for 3 seconds.

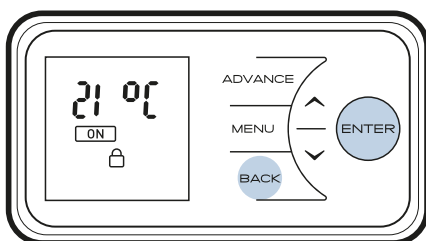

NOTE:

The controls cannot be adjusted when Child Lock is active.

User Information



Temp units - Choose whether your unit displays degrees Celsius or degrees Fahrenheit

Setpoint - The heater comes from the factory with a temperature setting range of 7°C - 26°C.

The maximum temperature setting can be increased to 32°C using the Setpoint Function.

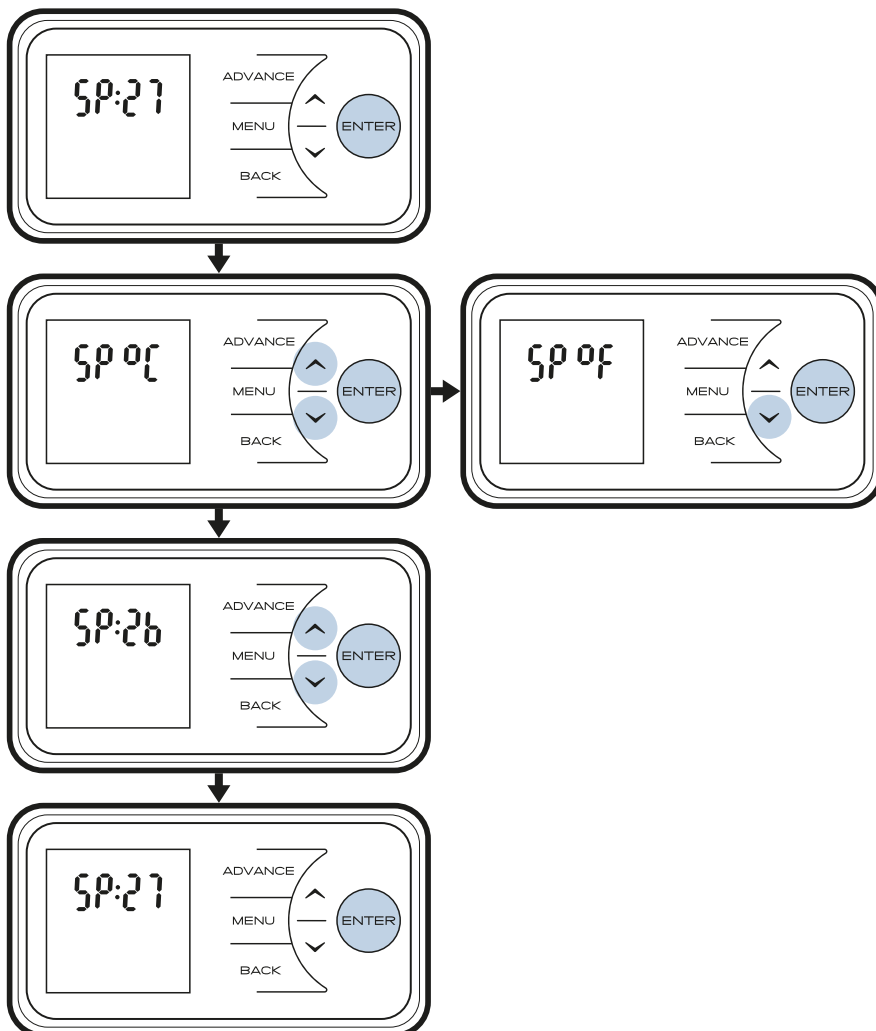
- Press the **Menu**, **Back** and **Enter** buttons and hold for 10 seconds
- The Set Point menu will be displayed.
- Press **Enter** to view the SP menu
- Press **Down** or **Up** to toggle between °C and °F
- Press **Enter** button to Confirm
- Press **Down** or **Up** to adjust the set point temperature
- Press **Enter** button to Confirm



Adaptive Start  - to achieve the desired temperature at the onset of the timed ON period the appliance anticipates when it needs to start heating prior to the onset of the timed period. E.g. room is 16°C, with 21°C at 7am set on the timer. With **Adaptive Start**  on the control will start to heat the room before 7am, reaching 21°C at this time. With **Adaptive Start**  off the heater will start to heat the room at 7am and will reach 21°C after this time.

- Press the **Menu** and **Advance** buttons and hold for 5 seconds
- The **Advance** menu is displayed
- Press **Up** twice to highlight the  icon
- Press **Enter** to access the **Adaptive Start** menu
- Press **Down** or **Up** to toggle Adaptive Start on/off
- Press **Enter** to confirm. Icon displayed on screen.

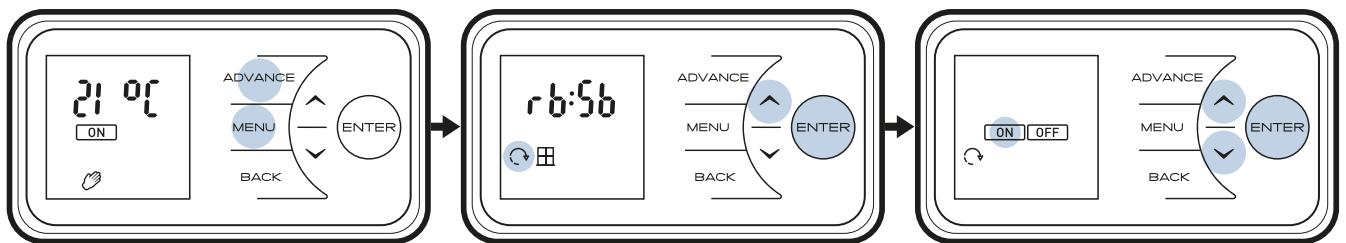

Open Window - The heater comes with a feature that will detect if a window is open and heat is being lost, so the heater will enter a reduced-power mode instead of using unnecessary energy. Open Window detection is activated by default. To activate/deactivate this feature:

- Press the **Menu** and **Advance** buttons and hold for 5 seconds
- The **Advance** menu is displayed
- Press **Up** three times to highlight the window icon
- Press **Enter** to access the  menu
- Press **Down** or **Up** to toggle Open Window on/off
- Press **Enter** to confirm

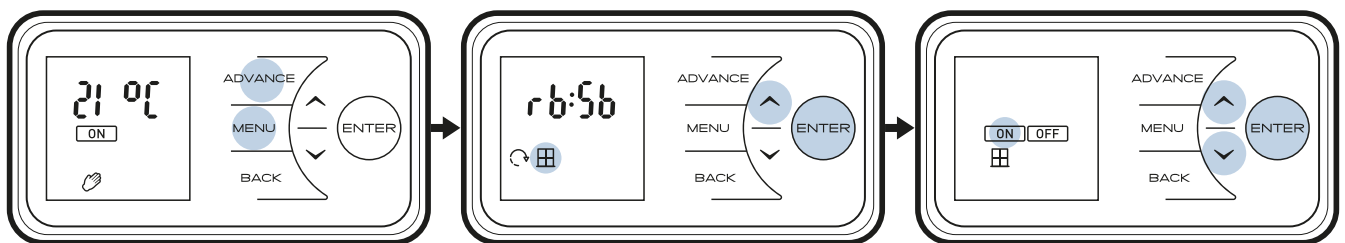

If Open Window detection is activated an Error Message will be displayed if the Heater detects an open Window “Err 2” will be displayed and the backlight & icon will flash.

Hold the **Enter** button for 10 seconds to cancel the error message

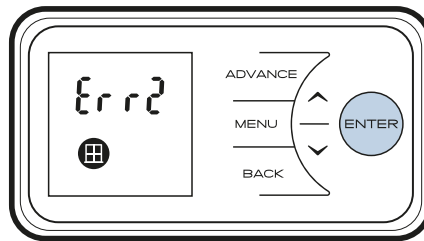

NOTE:

In environments where the product may read sudden decreases in temperature, this feature may activate in error. This can occur in drafty or poorly insulated environments as well as if the heater is undersized for the room. This feature should be disabled using the instructions above if activating for reasons other than the intended purpose. If you think that your environment is not as described here and this feature is activating, please contact our customer care team with the details on the rear page of this document.

Factory reset - Returns all settings to factory pre-sets.

- Press & hold **Enter** button for 5 seconds
- Press **Down** or **Up** to view Factory reset screen
- Press **Enter** to see factory reset options
- Press **Down** or **Up** to toggle between Y and N for reset.
- Press **Enter** to confirm

Factory reset sequence will now take place.

To reset the time/date see “Setting the Time and Date” on page 12.

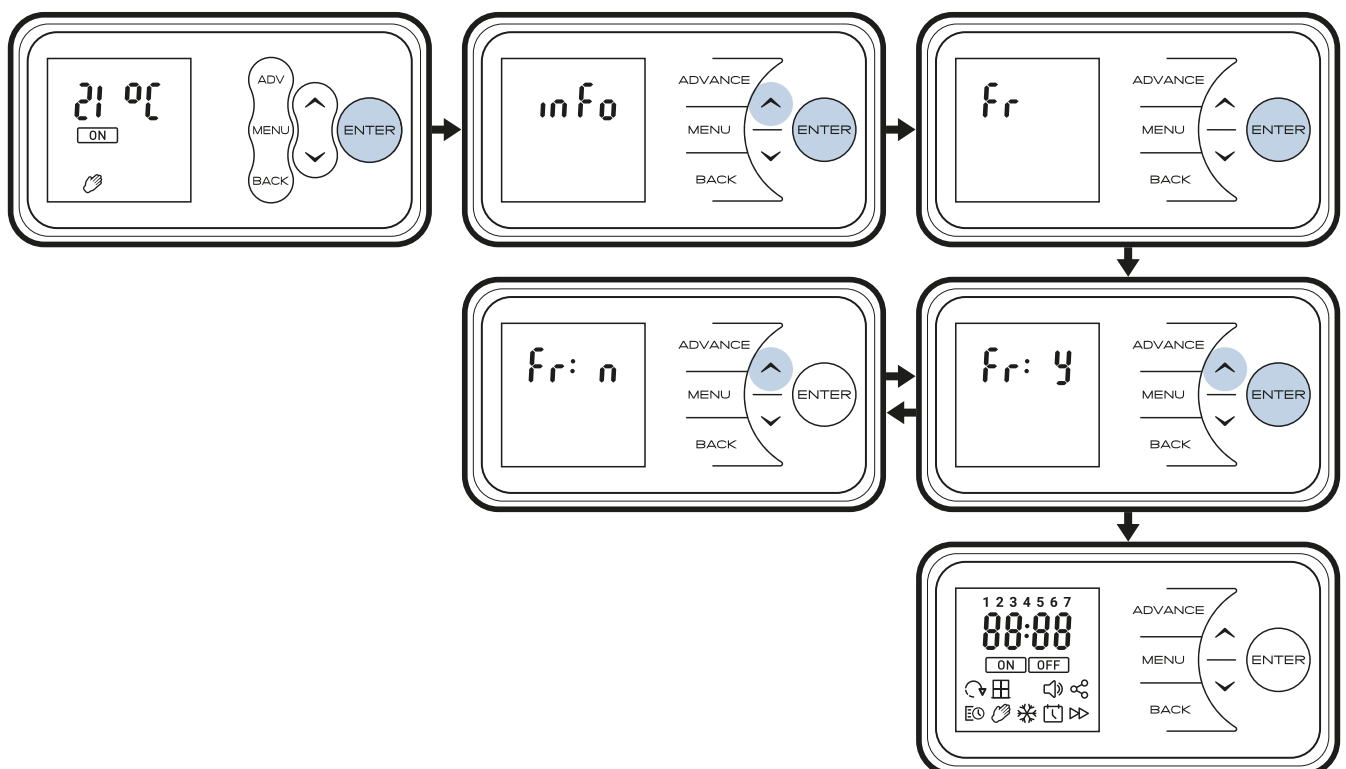

Service/User Info – Service info is displayed: UI rev, product ID

- Press & hold **Enter** button for 5 seconds
- Press **Enter** to view Info screen
- Press **Enter** to view UI revision number
- Press **Back** to return to UI screen
- Press **Up** to move to product ID screen
- Press **Enter** to view Product ID number
- Product ID is a 12 digit code, spread across 3 screens
- Press **Down** or **Up** to scroll through the ID number
- Press **Enter** to return to product ID screen

Press **Back** 3 times to return to the home screen.

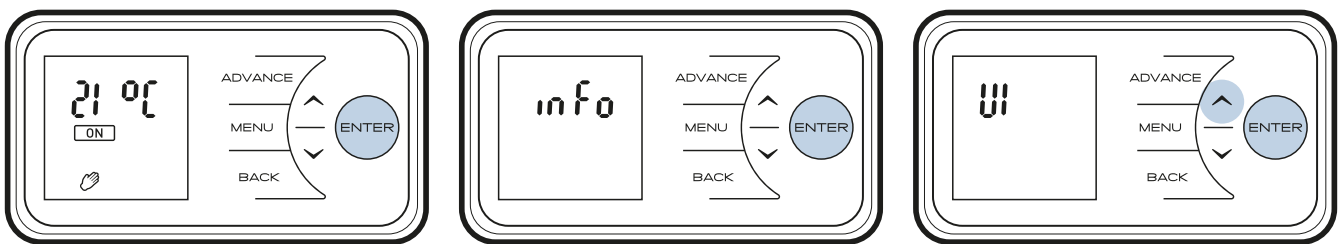

Error Messages

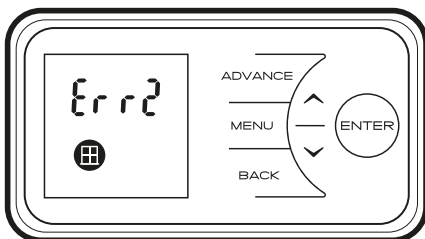

Error message 2 will be displayed when the product detects an open window in the room.

This error can be cleared by holding the **Enter** button for 10 seconds. Refer to the Open Window Detection Function on page 22 for further details.

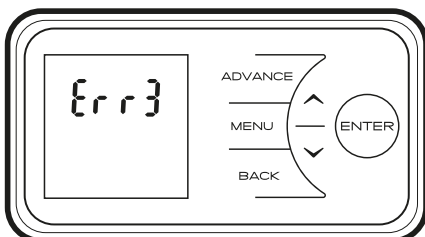

Error message 3 will be displayed on screen if the product has overheated.

This error can be cleared by removing the obstruction from the heater then holding the **Enter** button for 10 seconds.

Battery Replacement

IMPORTANT: Before replacing the battery ensure the heater is isolated from the electricity supply. **NOTE -** Battery should be disposed of in an appropriate manner

This product is fitted with a replaceable battery in the controls. To replace the battery, follow the steps below, shown in **Fig. 5**:

1. Unhinge the heater from the wall using the clips shown in **Fig. 2** and locate the battery module
2. Slide the catch and pull module from the controls.
3. Remove the coin cell battery and replace with a new 3.3V type CR2032, T85°C coin cell battery.
4. Slide module back in place, ensuring clip is engaged.

Fig. 5

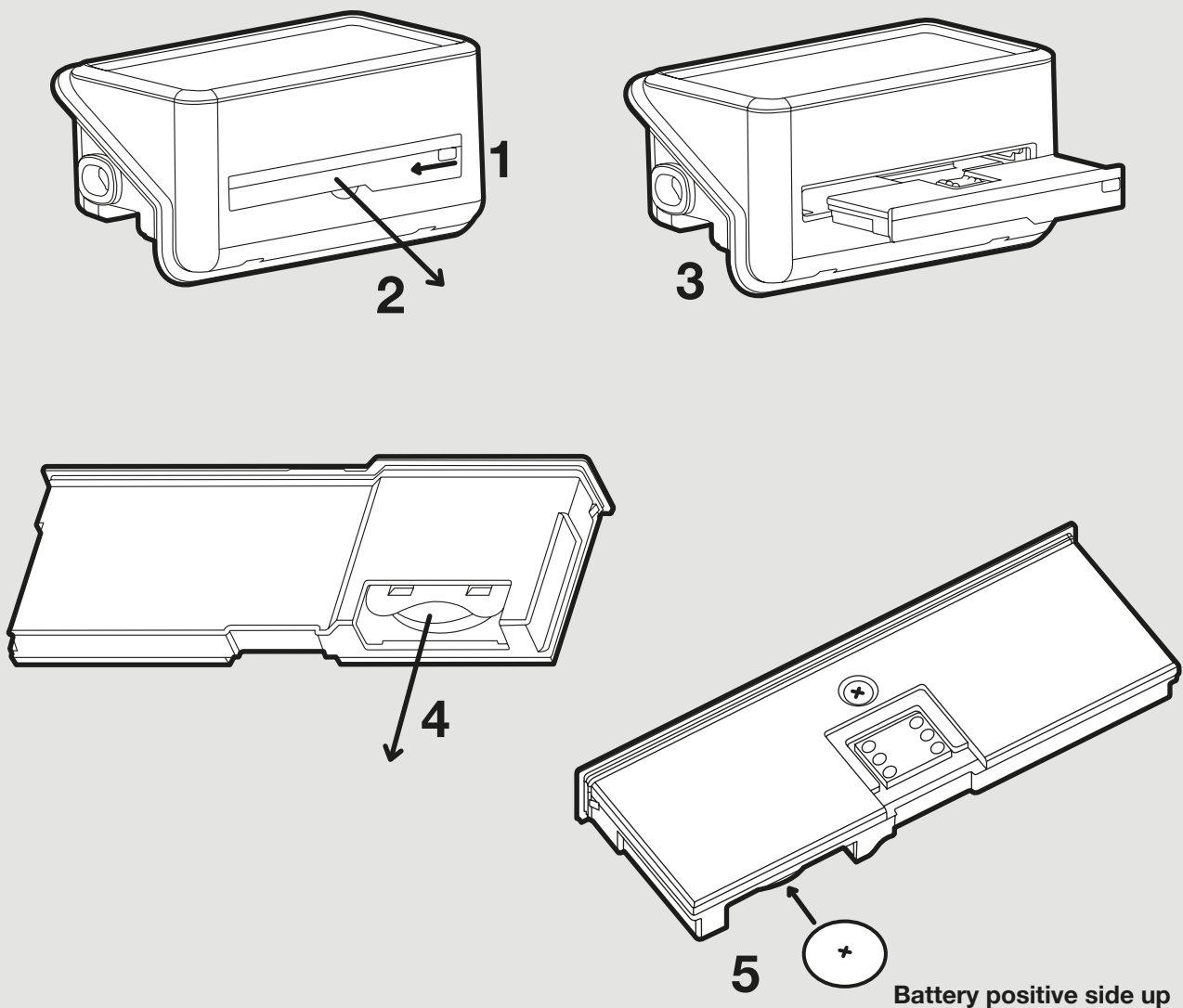

Important

During the initial operation, some odour may be noticed due to the newness of materials used in manufacture. This is normal and will disappear after a short period of use. It is however advisable to keep the room well ventilated.

Cleaning

WARNING - ALWAYS DISCONNECT FROM THE POWER SUPPLY BEFORE CLEANING THE HEATER.

Before commencing cleaning, isolate the heater from the electrical supply and allow it to cool. The outside can be cleaned by wiping it over with a soft damp cloth and then dried. Do not use abrasive cleaning powders or furniture polish, as this can damage the surface finish. To release the heater from the wall bracket for cleaning or redecoration, depress the latch on both brackets (See **Fig. 2**) and hinge forward.

Important



For electrical products sold within the European Community. At the end of the electrical products useful life it should not be disposed of with household waste. Please recycle where facilities exist. Check with a Local Authority or retailer for recycling advice in your country. Batteries should be disposed of or recycled in accordance with WEEE Directive 2012/19/EU. Packaging should be recycled where possible.

What does a Creda Guarantee cover?

Creda products deliver reliable service for normal, household use in domestic settings. All Creda products are individually tested before leaving the factory.

If you are a consumer and you experience a problem with your Creda product, which is found to be defective due to faulty materials or workmanship within the Guarantee Period, this Creda Guarantee will cover repair or - at the discretion of Creda - replacement with a functionally equivalent Creda product.

The Creda Guarantee Period is two calendar years from the date of purchase of your Creda product, or the date of delivery of the product, if later. The Creda Guarantee is conditional upon you providing the original purchase receipt as proof of purchase. Please therefore retain your receipt as proof of purchase.

If you do experience a problem with your Creda product please call the Helpline on 0344 879 35 88 or visit <http://www.credaheating.co.uk/contact> and complete the online form. For ROI please email serviceireland@glendimplex.com or call +353(0)1 842 833. We will need details of your Creda product, its serial number and a description of the fault which has occurred. You can find the model number and serial number for your Creda product on the heaters side. Once we receive your information and proof of purchase we will contact you to make the necessary arrangements.

If your Creda product is not covered by this Creda Guarantee there may be a charge to repair your product. However, we will contact you for agreement to any charges before any chargeable service is carried out.

What is not covered by a Creda Guarantee?

The Creda Guarantee does not cover any of the following:

- Any fault or damage to your Creda product due to faulty materials or workmanship occurring outside the two-year Guarantee Period.
- Any fault or damage occurring to any pre-owned Creda product or to any other equipment or property.
- Accidental damage to your Creda product or damage to your Creda product from external sources (for example, transit, weather, electrical outages or power surges).
- Fault or damage to your Creda product which is:
 - Not due to faulty materials or workmanship or which is due to circumstances outside Creda's control.
 - Caused by use of your Creda product for anything other than normal domestic household purposes in the country where it was purchased.

- Caused by any misuse, abuse or negligent use of the Creda product, including but not limited to any failure to use it in accordance with the Operating Instructions supplied with the product.
- Caused by any failure to assemble, install clean and maintain your Creda product in accordance with the Operating Instructions supplied with the product unless this was carried out by Creda or its authorised dealers.
- Caused by repairs or alterations to your Creda product not carried out by Creda service personnel or its authorised dealer(s).
- Caused by use of any consumables or spare parts for your Creda product which are not Creda -specified.

Terms and Conditions

- The Creda Guarantee is valid for Creda from the date of purchase of your Creda product from a recognised retailer in the country of purchase and use, or the date of delivery of the product if later, always provided the original receipt has been retained and is produced as proof of purchase.
- You must provide to Creda or its authorised agents on request the original receipt as proof of purchase and - if required by Creda - proof of delivery. If you are unable to provide this documentation, you will be required to pay for any repair work required.
- Any repair work under the Creda Guarantee will be carried out by Creda or its authorised dealer(s) and any parts that are replaced will become the property of Creda. Any repairs performed under the Creda Guarantee will not extend the Guarantee Period.
- Any replacement of your Creda product by Creda during the Guarantee Period will start the two-year Guarantee Period afresh from the date of delivery of the replacement Creda product to you.
- The Creda Guarantee does not entitle you to recovery of any indirect or consequential loss or damage including but not limited to loss or damage to any other property.
- The Creda Guarantee is in addition to your statutory rights as a consumer and your statutory rights are not affected by this Creda Guarantee.

Contact Creda

If you have any questions about what the Creda Guarantee covers and does not cover or how to claim under the Creda Guarantee, please contact us using the information on the back page.

Contact details

Glen Dimplex Heating and Ventilation
Millbrook House, Grange Drive, Hedge End, Southampton, SO30 2DF

Creda

HEATING

Customer Service Helpline: 0344 879 35 88

aftersales@credaheating.co.uk

www.credaheating.co.uk

Glen Dimplex Heating and Ventilation

Millbrook House, Grange Drive, Hedge End, Southampton, SO30 2DF

© GDC Group Ltd. trading as Glen Dimplex Heating and Ventilation "GDHV". All rights reserved. Material contained in this publication may not be reproduced in whole or in part, without prior permission in writing of Creda Heating. A division of GDC Group Ltd.

CE This product complies with the European Safety Standards EN60335-2-30 and the European Standard Electromagnetic Compatibility (EMC) EN55014, EN61000-3-2 and EN61000-3-3. These cover the essential requirements of EEC Directives 2014/35/EU and 2014/30/EU