



D Series with

# DELTA Ultimate

technology

## Rointe Digital Integral Heating System

The new heating system  
with **Wi-Fi Inside.**



We bring warmth  
to your home.  
[www.rointe.co.uk](http://www.rointe.co.uk)

Control your heating  
anytime, anywhere.

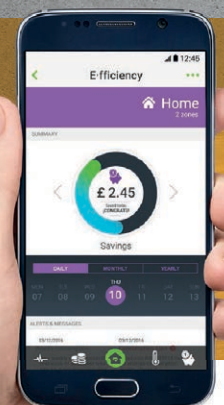

## Rointe Digital Integral System

A unique system which covers all your heating and domestic hot water requirements

radiator + towel-rails + water heater

### D Series

with DELTA Ultimate technology is...

#### COMFORT AND WELL-BEING

The Rointe Integral Digital System covers the 3 essential parameters to ensure true well-being in a comfortable environment:

Temperature stability  $\pm 21^{\circ}\text{C}$   
 $\pm 0.25^{\circ}\text{C}$

Relative humidity 30%/70%

Air speed  $< 0,1\text{m/s}$



#### LOW CONSUMPTION TECHNOLOGY

Tests carried out in independent laboratories prove that the low consumption "Fuzzy Logic Energy Control" helps the products to achieve a **co-efficient of non-consumption of 62%** of the nominal power.



#### DIRECT WIFI COMMUNICATION WITHOUT GATEWAYS

The joining of Wi-Fi Inside and E-Life technology makes the D Series the only system which **doesn't need gateways or intermediary terminals in order to work**. The connection between the product and the application is established directly ensuring an immediate connection.



#### MOBILE CONNECTION

Control your heating in the easiest way by internet via the **Rointe Connect App** (available for **smartphone, tablet and Pc**) whenever you want and wherever you are. It is an application for iOS, Android and web platform for other operating systems.

#### TOTAL CONTROL OF COSTS

Efficiency shows you how efficiently you are using your heating system. It lets you **know the statistics of temperature, consumption, running costs and savings accumulated** in real time thanks to the incorporation of the current meter "True Real Power" in all the D Series products.

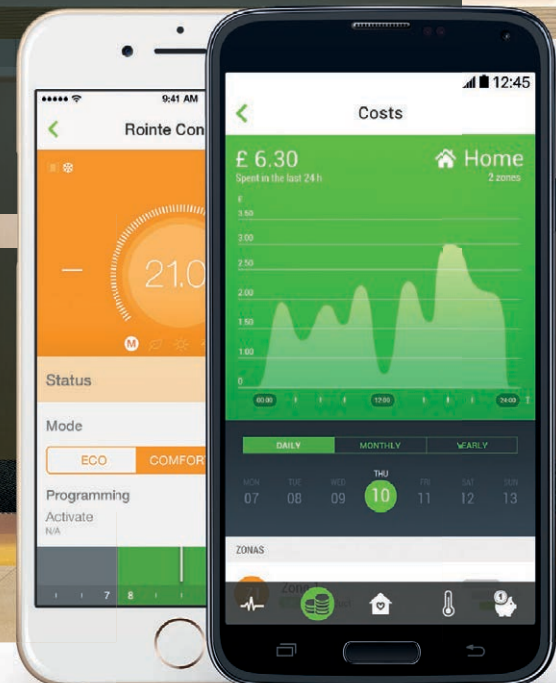



# D series with DELTA Ultimate technology

Thanks to the high quality components and the versatility that the mobile control offers, the D Series heating and domestic hot water systems bring comfort and wellbeing to demanding clients such as homes, hotels, retirement homes, student residences, colleges and universities.



reception

WELCOME · BIENVENIDO · BIENVENUE · WILLKOMMEN

NEW!

# E·fficiency

## The real consumption in real time\*

Rointe presents **E·fficiency**, the new update in Rointe Connect which lets you know at first-hand **how efficiently you are using the heating system**. It also lets you know the temperatures, consumption, running costs and savings accumulated in real time from your mobile, tablet or computer.

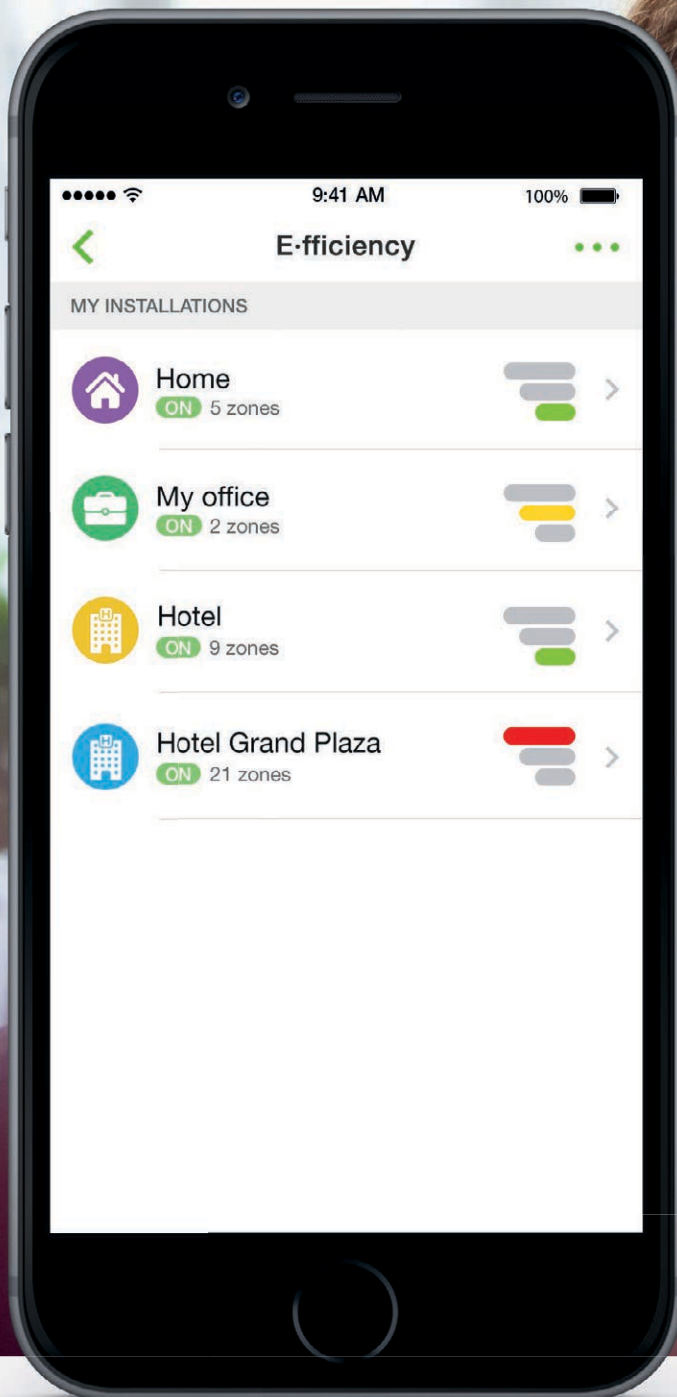

## Comprehensive energy indicator

E·fficiency shows you **how efficiently you are using your heating installation**

E·fficiency shows the relation between consumption, temperatures, active programs and working time, using a 3 colour scale: red, yellow and green, to show the user the energy performance of their system. This may be excessive (red), for revision (yellow) or efficient (green).

\* The measurements were carried out by Rointe under stable, controlled conditions with a percentage of variability in the result. The value shown in the measurement may differ depending on conditions such as the network or other values. Rointe is not responsible that these variations affect the result. To ensure the correct measurements the products should be connected at all times to the internet as a simple disconnection, however short it may be, may result in giving the wrong results. For more information, please consult the terms and conditions of E·fficiency in the Rointe Connect App.





E:fficiency is made up of 5 main screens:

See how much you save!

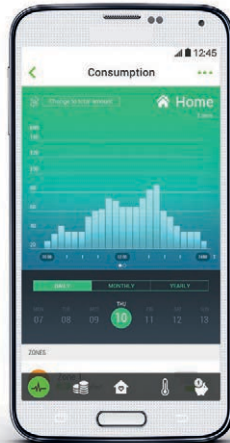

**Consumption**  
Shows the real energy consumption by installation, zone or product.



**Economic cost**  
This lets you know the real cost of using the heating system per day, month or year.



**Temperature**  
Here you can see the temperature that has been set and that read by the product sensor.

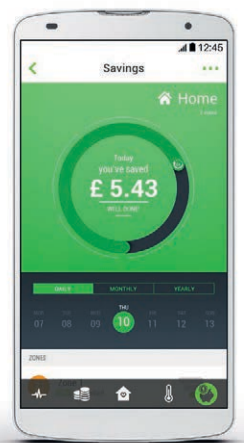

**Savings accumulated\*\***  
This shows the savings accumulated by having the D Series heating system.

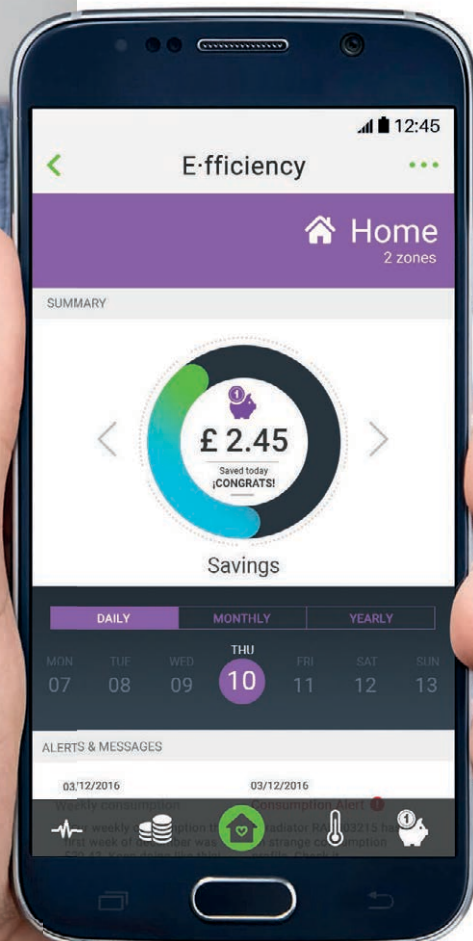

## Summary of use

See at a glance how the system is working

This is the main screen of E:fficiency, where you can quickly find a summary of the use of your heating which interests you:



- Consumption of the installation in £ and kWh by day, month or year\*
- Effective power consumed in relation to the nominal power
- Daily, monthly and yearly savings accumulated\*\*
- Data traffic consumed by your products

















\*\* The value shown on the "SAVINGS" screen is the total of the savings of all the products which are installed. This saving is calculated by subtracting the effective power of the product from its nominal power then multiplying this figure by the price per kWh and the hours of use.

# D Series radiator with DELTA Ultimate technology



**AVAILABLE FINISHES**

-  White
-  Graphite forge effect
-  RAL colour\*

-  Fuzzy Logic Energy Control: energy smart technology
-  100% aluminium radiator with end panels
-  Optimized design for maximum heat dissipation
-  Two SMD electronics board circuits, lithium battery and triac
-  Optimum balance with 110 w/element
-  Finish available in RAL colours\*
-  1.77" TFT screen with background colour personalisation
-  Elife Technology: home automation technology
-  USER Mode: possibility of assigning working temperatures range
-  Wireless communication via WIFI and infrared
-  Advanced control panel with touch control
-  True Real Power: smart data consumption meter\*\*
-  "Open window" energy smart function
-  Product functionality accessible through visual menus
-  Consumption and control statistics\*\*
-  10 year warranty on aluminium and 2 years on electronics

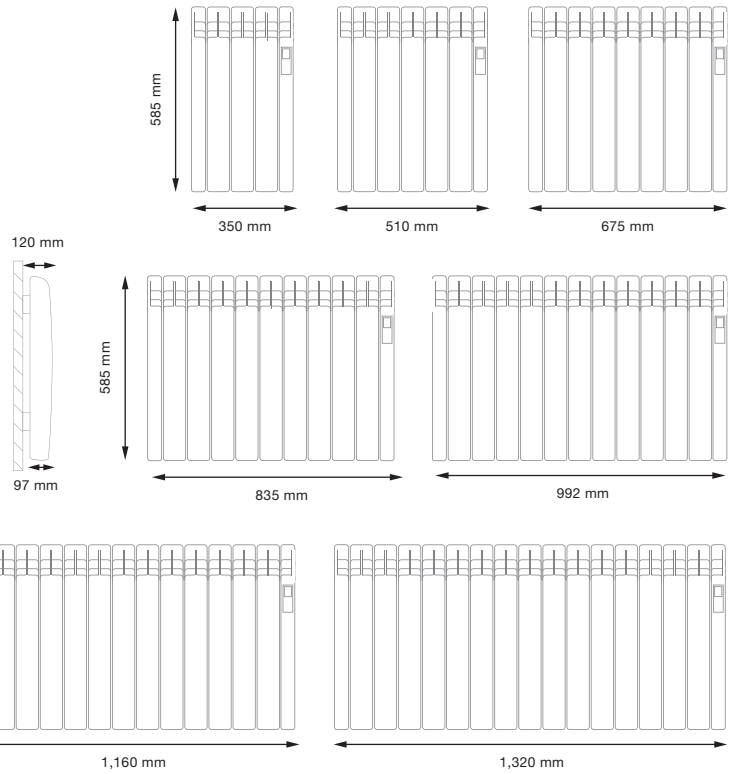

**INFRARED**   **wifiinside**   **e.life** technology   **IP24C**

\*Personalised colour available upon demand. Call us for further details and lead time. For any info on the RAL colour finishes please ask us for the colour chart. \*\* The measurements were carried out by Rointe under stable, controlled conditions with a percentage of variability in the result. The value shown in the measurement may differ depending on conditions such as the network or other values. Rointe is not responsible that these variations affect the result. To ensure the correct measurements the products should be connected at all times to the internet as a simple disconnection, however short it may be, may result in giving the wrong results. For more information, please consult the terms and conditions of Efficiency in the Rointe Connect App.

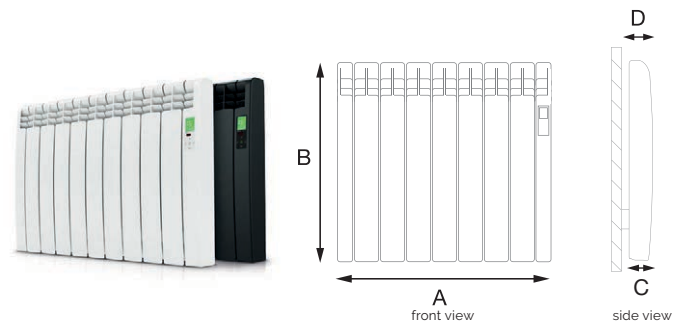

MODELS	WHITE	DIW0330RAD	DIW0550RAD	DIW0770RAD	DIW0990RAD	DIW1210RAD	DIW1430RAD	DIW1600RAD
	GRAPHITE	DIB0330RAD	DIB0550RAD	DIB0770RAD	DIB0990RAD	DIB1210RAD	DIB1430RAD	DIB1600RAD
	RAL COLOUR	DIR0330RAD	DIR0550RAD	DIR0770RAD	DIR0990RAD	DIR1210RAD	DIR1430RAD	DIR1600RAD
N° of elements		3	5	7	9	11	13	15
<b>DIMENSIONS</b>								
A (mm) - Width		350	510	675	835	992	1,160	1,320
B (mm) - Height		585	585	585	585	585	585	585
C (mm) - Depth		97	97	97	97	97	97	97
D (mm) - Installed depth		120	120	120	120	120	120	120
<b>MECHANICAL CHARACTERISTICS</b>								
Armoured steel heating element		●	●	●	●	●	●	●
Curved design with Slim Line Aluminium end panels		●	●	●	●	●	●	●
High purity aluminium		●	●	●	●	●	●	●
Thermal oil		●	●	●	●	●	●	●
Control panel with touch keyboard		●	●	●	●	●	●	●
Weight (Kg)		7.7	12.2	16.4	20.4	24.1	25.9	32.1
Weight with packaging (Kg)		8.8	13.3	17.5	21.5	25.2	27.0	33.2
Finishes		White RAL 9016 / Graphite forge effect / RAL Colour						
<b>ELECTRICAL CHARACTERISTICS</b>								
Nominal power (W)		330	550	770	990	1,210	1,430	1,600
Effective power (W)*		125	209	293	376	460	543	608
Voltage (V)		230 V ~	230 V ~	230 V ~	230 V ~	230 V ~	230 V ~	230 V ~
Current (A)		1.5	2.4	3.4	4.3	5.3	6.2	7.0
<b>FUNCTIONALITY</b>								
TFT screen (1.77")		●	●	●	●	●	●	●
Eco / Comfort / Antifrost Modes		●	●	●	●	●	●	●
New User mode		●	●	●	●	●	●	●
Manual / Automatic function		●	●	●	●	●	●	●
Screen brightness control		●	●	●	●	●	●	●
Nominal and effective power		●	●	●	●	●	●	●
Open windows function		●	●	●	●	●	●	●
Programmable 24/7 using keypad, Rointe Connect App or AIR Control		●	●	●	●	●	●	●
<b>PERFORMANCE AND SECURITY</b>								
Fuzzy Logic Energy Control		●	●	●	●	●	●	●
E-life Technology & Wi-Fi Inside		●	●	●	●	●	●	●
True Real Power & ULP32 microcontroller		●	●	●	●	●	●	●
Wireless communication		WiFi / Two-way infrared						
Temperature stability (°C)		±0.25	±0.25	±0.25	±0.25	±0.25	±0.25	±0.25
Air velocity (m/s)		< 0.1	< 0.1	< 0.1	< 0.1	< 0.1	< 0.1	< 0.1
Power per element (W/element)		110	110	110	110	110	110	110
Safety thermostat		●	●	●	●	●	●	●
Average surface temp. during steady period (°C)**		40 °C	40 °C	40 °C	40 °C	40 °C	40 °C	40 °C
Protection grade		IP24C	IP24C	IP24C	IP24C	IP24C	IP24C	IP24C
<b>INSTALLATION</b>								
Template & Installation kit		●	●	●	●	●	●	●
<b>CERTIFICATIONS</b>								
2004/108/CE Electromagnetic Comp.		●	●	●	●	●	●	●
2006/95/CE Electronic Security		●	●	●	●	●	●	●
EAN CODE	WHITE	8436045913708	8436045913715	8436045913722	8436045913739	8436045913746	8436045913753	8436045913760
	GRAPHITE	8436045913777	8436045913784	8436045913791	8436045913807	8436045913814	8436045913821	8436045913838
	RAL COLOUR	8436045916235 -xxx**	8436045916242 -xxx**	8436045916259 -xxx**	8436045916266 -xxx**	8436045916273 -xxx**	8436045916280 -xxx**	8436045916297 -xxx**
T.P.	WHITE	£ 352.00	£ 446.00	£ 558.00	£ 637.00	£ 707.00	£ 783.00	£ 874.00
	GRAPHITE	£ 373.00	£ 473.00	£ 591.00	£ 675.00	£ 750.00	£ 830.00	£ 926.00
	RAL COLOUR	£ 433.00	£ 573.00	£ 731.00	£ 855.00	£ 970.00	£ 1,090.00	£ 1,226.00





● incorporated ○ not incorporated □ optional ✕ not available / not applicable



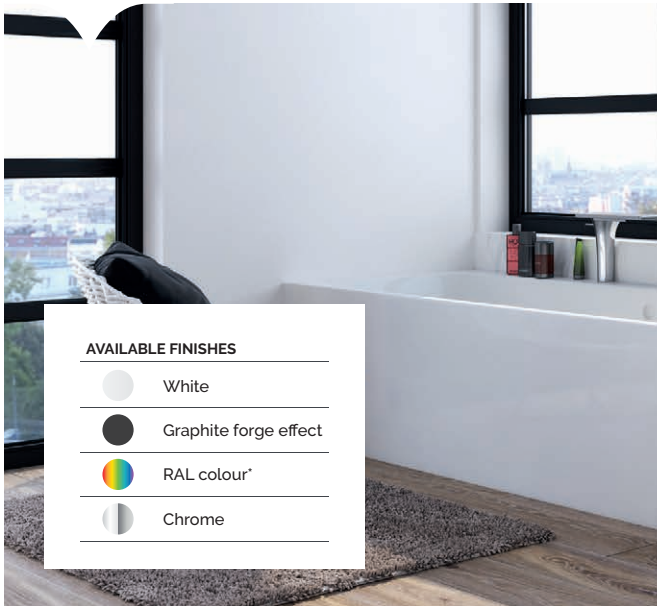











\* In tests carried out by independent laboratories under the same test conditions comparing a radiator with Fuzzy Logic Energy Control and another with Optimizer Energy Plus (the first Rointe energy control technology) there was a difference of 6.3% in the energy consumed. This saving means that the radiators with Fuzzy Logic Energy Control use an average of only 38% of their nominal power. This is what we define as the equivalent ratio of consumption. We obtain the effective power by multiplying the nominal power by the equivalent ratio of consumption. \*\* Average surface temperature obtained with the radiator temperature set to 21°C. \*\*\*The last 4 digits of the EAN code corresponds to the desired RAL colour code. For any info on the RAL colour finishes please ask us for the colour chart.



# D Series towel-rails with DELTA Ultimate technology



- AVAILABLE FINISHES**
-  White
  -  Graphite forge effect
  -  RAL colour\*
  -  Chrome

-  Curved steel body design
-  Optimal ratio between heating element and thermal fluid
-  Two SMD electronics board circuits, lithium battery and ULP32 mcu
-  Advanced control panel with touch control
-  1.77" TFT screen with background colour personalisation
-  Available in three finishes and in RAL colours\*
-  E-life Technology: home automation technology
-  Wireless communication via WiFi and infrared
-  User Mode: possibility of assigning working temperatures range
-  True Real Power: smart data consumption meter\*\*
-  2 hour boost function
-  "Open window" energy smart function
-  Product functionality accessible through visual menus
-  Consumption and control statistics\*\*
-  10 year warranty on steel body and 2 years on electronics

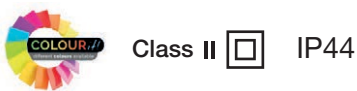
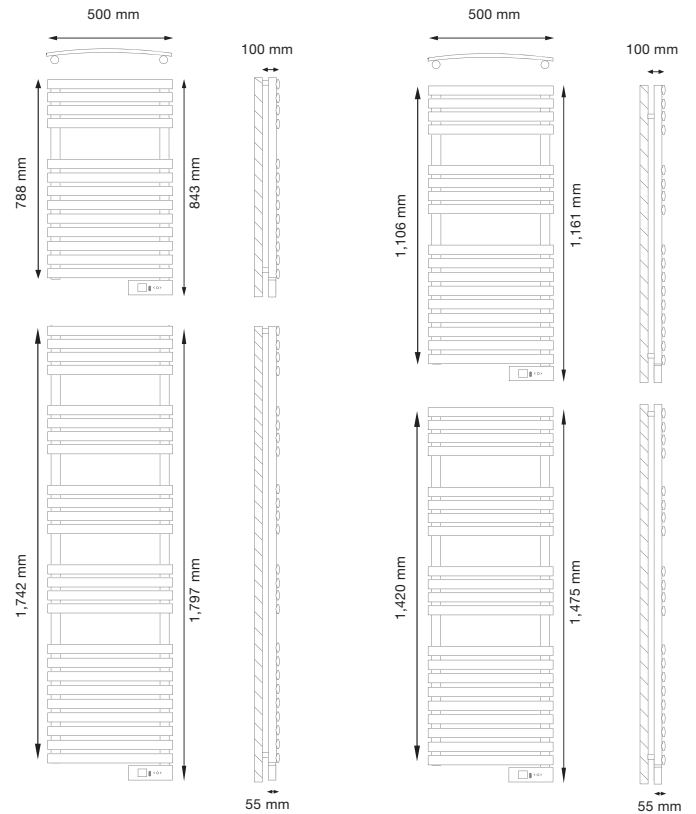

\*Personalised colour available upon demand. Call us for further details and lead time. For any info on the RAL colour finishes please ask us for the colour chart. \*\* The measurements were carried out by Rointe under stable, controlled conditions with a percentage of variability in the result. The value shown in the measurement may differ depending on conditions such as the network or other values. Rointe is not responsible that these variations affect the result. To ensure the correct measurements the products should be connected at all times to the internet as a simple disconnection, however short it may be, may result in giving the wrong results. For more information, please consult the terms and conditions of Efficiency in the Rointe Connect App.

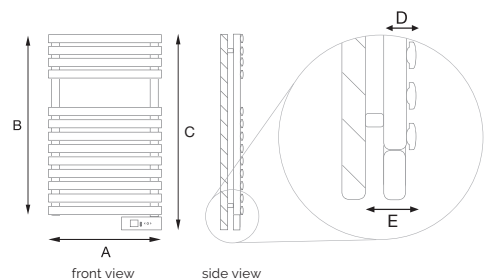



MODELS	WHITE	DTI030SEW	DTI045SEW	DTI060SEW	DTI075SEW
	GRAPHITE	DTI030SEB	DTI045SEB	DTI060SEB	DTI075SEB
	RAL COLOUR	DTI030SER	DTI045SER	DTI060SER	DTI075SER
	CHROME	DTI030SEC	DTI045SEC	DTI060SEC	DTI075SEC
<b>DIMENSIONS</b>					
A (mm) - Width		500	500	500	500
B (mm) - Height without control panel		788	1,106	1,420	1,742
C (mm) - Height with control panel		843	1,161	1,475	1,797
D (mm) - Depth		55	55	55	55
E (mm) - Installed depth		100	100	100	100
<b>MECHANICAL CHARACTERISTICS</b>					
Armoured steel heating element		●	●	●	●
Thermal fluid		●	●	●	●
PC/ABS control panel with touch keyboard		●	●	●	●
Weight (Kg)		13	17	21	25
Finishes	White RAL 9016 / Graphite Forge Effect / RAL colour / Chrome				
Design	Curved				
<b>ELECTRICAL CHARACTERISTICS</b>					
Nominal power (W)	White / Graphite / RAL	300	450	600	750
	Chrome	300	300	450	600
Voltage (V)		230 V ~	230 V ~	230 V ~	230 V ~
Current (A)	White / Graphite / RAL	1.30	1.96	2.61	3.26
	Chrome	1.30	1.30	1.96	2.61
Class II heating element		●	●	●	●
<b>FUNCTIONS</b>					
TFT screen (1.77")		●	●	●	●
Manual / Automatic function		●	●	●	●
Eco / Comfort / Antifrost modes		●	●	●	●
New User mode		●	●	●	●
Open windows function		●	●	●	●
Screen brightness control		●	●	●	●
2 hr boost function		●	●	●	●
Programmable 24/7 using touch pad, Rointe Connect App or AIR Control remote		●	●	●	●
<b>PERFORMANCE AND SECURITY</b>					
E-life Technology & Wi-Fi Inside		●	●	●	●
True Real Power & Rointe ULP32 Microcontroller		●	●	●	●
Wireless communication		WiFi / Two-way infrared			
Fire proof cabling		●	●	●	●
Safety thermostat		●	●	●	●
Protection grade		IP 44	IP 44	IP 44	IP 44
<b>INSTALLATION</b>					
Template		●	●	●	●
Installation kit		●	●	●	●
<b>CERTIFICATIONS</b>					
2004/108/CE Electromagnetic compatibility		●	●	●	●
2006/95/CE Electronic security		●	●	●	●
EAN CODE	WHITE	8436045913920	8436045913937	8436045913944	8436045913951
	GRAPHITE	8436045913883	8436045913890	8436045913906	8436045913913
	RAL COLOUR	8436045916303-xxxx**	8436045916310-xxxx**	8436045916327-xxxx**	8436045916334-xxxx**
	CHROME	8436045913845	8436045913852	8436045913869	8436045913876
T.P.	WHITE	£ 423.00	£ 476.00	£ 519.00	£ 576.00
	GRAPHITE	£ 493.00	£ 616.00	£ 690.00	£ 759.00
	RAL COLOUR	£ 590.00	£ 656.00	£ 705.00	£ 752.00
	CHROME	£ 535.00	£ 686.00	£ 796.00	£ 921.00

● incorporated ○ not incorporated □ optional ✕ not available / not applicable

\*The last 4 digits of the EAN code corresponds to the desired RAL colour code. For any info on the RAL colour finishes please ask us for the colour chart.

# D Series water heater with DELTA Ultimate technology



**Mandatory requirement**  
Unvented water heaters installation in the United Kingdom

In the United Kingdom it is mandatory for all models of unvented domestic hot water heaters to be installed with an installation kit (sold separately). This kit is composed of:



Pressure reducing valve & relief valve



Tundish



Expansion vessel

Rointe sell three different kits depending on the size of the model. For further details and installation scheme, please see page 15.

- Fuzzy Logic Energy Control: energy smart technology
- Enamelled tank: half mm enamel coating to protect against corrosion
- Two heating elements connected in parallel which work independently
- 3 cm thick rigid polyurethane foam that has a low thermal conductivity
- Two SMD electronics board circuits, lithium battery and triac
- 1.77" TFT screen with background colour personalisation
- E-life Technology: home automation technology
- Water heating progress function: shows the availability of hot water
- Periodical anti-legionnaires' disease protection
- User Mode: possibility of assigning working temperatures range
- Wireless communication via WI-FI and infrared
- Advanced control panel with touch control
- True Real Power: smart data consumption meter\*
- Product functionality accessible through visual menus
- Consumption and control statistics\*
- 5 year guarantee on the water heater body and 2 years on electronics

**Squared range models**  
D Series water heater - 50 - 75 - 100 L

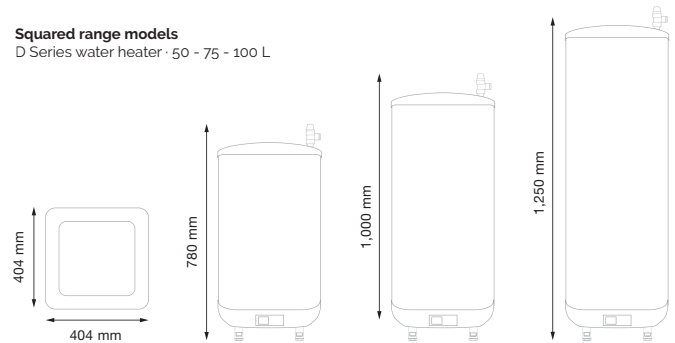

**Cylinder range models**  
D Series water heater - 150 - 200 L

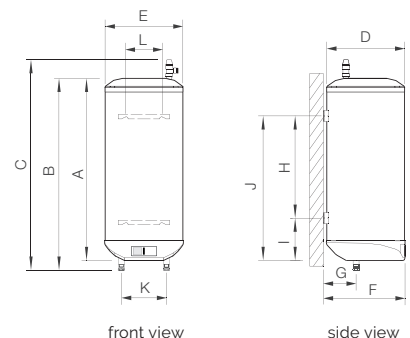
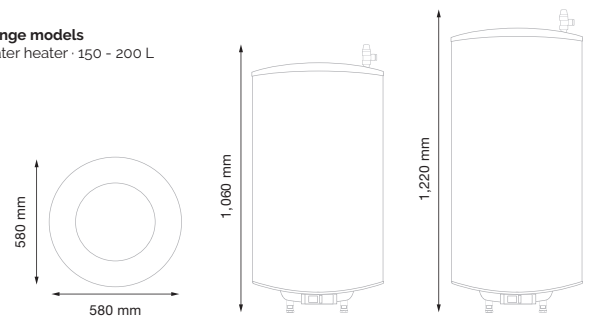

\* The measurements were carried out by Rointe under stable, controlled conditions with a percentage of variability in the result. The value shown in the measurement may differ depending on conditions such as the network or other values. Rointe is not responsible that these variations affect the result. To ensure the correct measurements the products should be connected at all times to the internet as a simple disconnection, however short it may be, may result in giving the wrong results. For more information, please consult the terms and conditions of Efficiency in the Rointe Connect App.



MODELS	DWI050DHW2	DWI075DHW2	DWI100DHW2	DWI150DHW2	DWI200DHW2
Volume	50	75	100	150	200
<b>DIMENSIONS</b>					
A (mm) - Height	640	860	1,100	900	1,070
B (mm) - Height with connections	680	900	1,150	960	1,120
C (mm) - Total height with T/P valve	780	1,000	1,250	1,060	1,220
D (mm) - Width	404	404	404	580	580
E (mm) - Depth	404	404	404	580	580
F (mm) - Installed depth	420	420	420	620	620
G (mm) - Depth from the connections to the wall	120	120	120	178	178
H (mm) - Vertical distance between fixing holes	340	573	768	595	685
I (mm) - Vert. dist. lower fixing holes & connections	130	142	192	250	250
J (mm) - Vert. dist. upper fixing holes & connections	470	715	960	845	935
K (mm) - distance between connections	160	160	160	235	235
L (mm) - Horizontal distance between fixing holes	350	350	350	350	350
<b>INSTALLATION</b>					
Position	Vertical				
Water connection (inches)	1/2"	1/2"	1/2"	3/4"	3/4"
Electrolytic fittings	●	●	●	●	●
Support Tripod (optional)	×	×	×	□	□
<b>MECHANICAL CHARACTERISTICS</b>					
Control panel with touch keyboard	●	●	●	●	●
Maximum working pressure (bar)	9	9	9	9	9
Enamelled steel tank	●	●	●	●	●
Magnesium anode protector	●	●	●	●	●
CFC free polyurethane insulation	●	●	●	●	●
Empty weight (kg)	18	25	32	44	56
Finish	White RAL 9016				
<b>ELECTRICAL CHARACTERISTICS</b>					
N° Heating Elements x Power (W)	2 x 1,200	2 x 1,200	2 x 1,200	2 x 1,200	2 x 1,200
Nominal power (W)	2,400	2,400	2,400	2,400	2,400
Voltage (V)	230 V ~	230 V ~	230 V ~	230 V ~	230 V ~
Current (A)	10.4	10.4	10.4	10.4	10.4
<b>FUNCTIONALITY</b>					
TFT Screen (1.77")	●	●	●	●	●
Manual / Automatic functions	●	●	●	●	●
ECO / Comfort / Antifrost modes	●	●	●	●	●
New User mode	●	●	●	●	●
Anti-legionella & temperature evolution functions	●	●	●	●	●
Screen brightness control	●	●	●	●	●
Nominal and effective power	●	●	●	●	●
Programmable 24/7 using Pad, App or Remote Control	●	●	●	●	●
<b>PERFORMANCE AND SECURITY</b>					
Fuzzy Logic Energy Control	●	●	●	●	●
E-Life Technology & Wi-Fi Inside	●	●	●	●	●
True Real Power & Rointe ULP32 Microcontroller	●	●	●	●	●
Wireless communication	WiFi / Two-way infrared				
Cold water entry diffuser, safety valve & safety thermostat	●	●	●	●	●
Steady state consumption (kWh/24h)	1.1	1.2	1.4	1.9	2.3
Energy certification	B	B	B	B	B
Protection grade	IP X4	IP X4	IP X4	IP X4	IP X4
<b>PROTECTION GRADE</b>					
004/108/EC Support Electromagnetic	●	●	●	●	●
2006/95/EC Electronic Security	●	●	●	●	●
<b>EAN CODE</b>					
	8436045913968	8436045913975	8436045913982	8436045913999	8436045914002
<b>T.P.</b>	<b>£ 693.00</b>	<b>£ 863.00</b>	<b>£ 956.00</b>	<b>£ 1,122.00</b>	<b>£ 1,273.00</b>







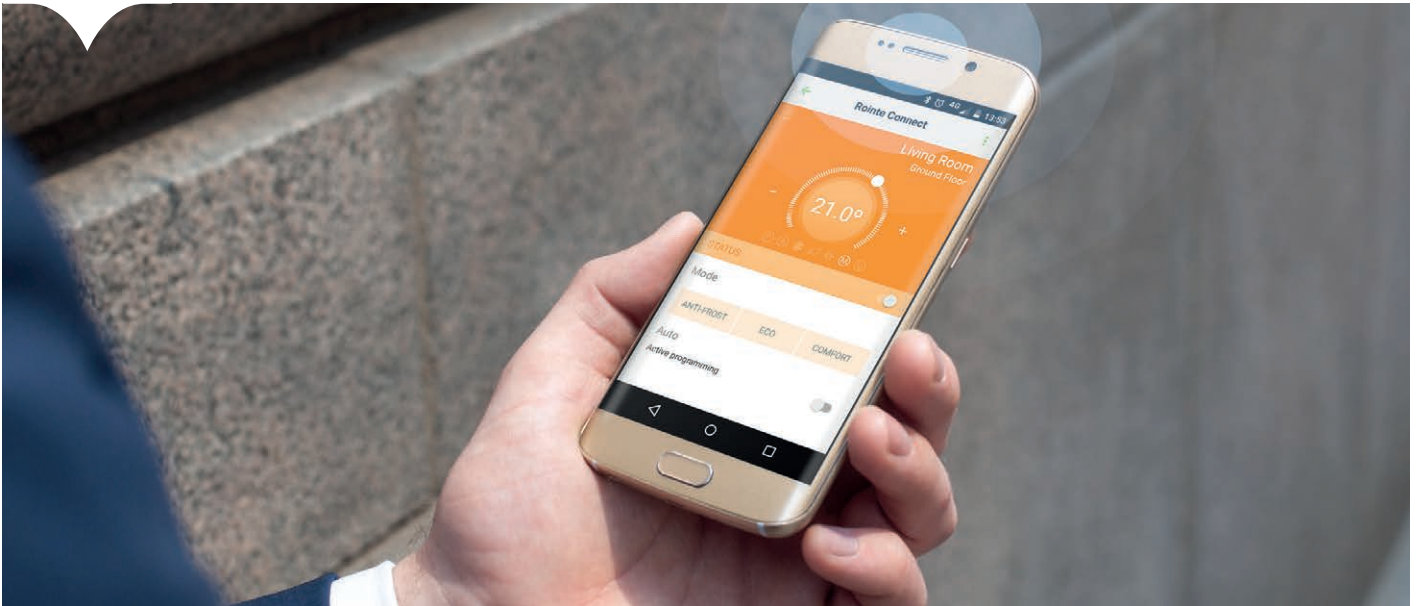

● incorporated ○ not incorporated □ optional × not available / not applicable

# Control App

## Rointe Connect

multiplatform



-  Multiplatform application for iOS, Android and web
-  Multi-device app available for smartphone, tablet or Pc
-  consumption statistics, average power, data...
-  Configure from a product to multi zoned homes or businesses
-  Installation wizard that guides step by step
-  Alerts and push notifications of any event in the installation
-  Regular updates
-  Total control 24/7 from any device with internet connection



VERSION	V 1.0.
<b>COMMUNICATION</b>	
Wireless Via Wi-Fi	●
<b>PLATFORMS</b>	
iOS 8.0 or higher & Android 4.0 or higher	●
Web (Google Chrome, Mozilla Firefox, Internet Explorer, Opera )	●
<b>FUNCTIONS</b>	
Alter the temperature	●
Programable 7 days a week/24 hours a day	●
Function Manual / Automatic	●
Remote control lock – Heating	●
Light and colour display change	●
View nominal and effective power	●
Open windows mode / User Mode	●
Statistics control - Temperature, power consumption, savings	●
Product pairing & management	●
Individual or zone control	●
Push notifications (coming soon)	●
<b>LANGUAGES</b>	
English, French, Portuguese & Spanish	●

● incorporated ○ not incorporated □ optional ✕ not available / not applicable





## Two-way infrared remote control

# AIR Control

*glossy white & soft touch black*

**NEW!**
**FINISHES AVAILABLE**

- Glossy white
- Soft touch black



- Ergonomic body made in PC/ABS
- Transparent wall bracket included
- SMD Electronics & Advanced technology
- 1.77" TFT screen
- Bi-directional infrared communication
- Compact mechanical keyboard
- Power by 1.5V AAA batteries
- Glossy white and soft touch black finishes
- 2 years guarantee

MODEL	ACMI120	ACMIB120
<b>DIMENSIONS</b>		
W (mm) - Width	54	54
H (mm) - Height	177	177
D (mm) - Depth	21	21
<b>MECHANICAL CHARACTERISTICS</b>		
Weight (grs)	115	115
Finishes	White RAL 9010	Black soft touch
Cover material	PC/ABS	PC/ABS
Range operating temperature	-20 to 55 °C	-20 to 55 °C
<b>ELECTRICAL CHARACTERISTICS</b>		
Power	3Vdc	3Vdc
Battery type	2 x 1.5 AAA	2 x 1.5 AAA
<b>COMMUNICATION</b>		
Wireless IR.	<input checked="" type="checkbox"/>	<input checked="" type="checkbox"/>
Transmitting - range (m)	3	3
Reception - range (m)	1	1
<b>INSTALLATION</b>		
Wall bracket	<input checked="" type="checkbox"/>	<input checked="" type="checkbox"/>
Installed depth with support (mm)	25	25
<b>FUNCTIONALITY</b>		
TFT screen (1.77")	<input checked="" type="checkbox"/>	<input checked="" type="checkbox"/>
24 hours / 7 days programmer	<input checked="" type="checkbox"/>	<input checked="" type="checkbox"/>
Manual / automatic function	<input checked="" type="checkbox"/>	<input checked="" type="checkbox"/>
Remote memory lock - heating and D.H.W.	<input checked="" type="checkbox"/>	<input checked="" type="checkbox"/>
Erasing programming memory	<input checked="" type="checkbox"/>	<input checked="" type="checkbox"/>
Screen brightness control - On / Stand-by mode	<input checked="" type="checkbox"/>	<input checked="" type="checkbox"/>
Display nominal and effective power	<input checked="" type="checkbox"/>	<input checked="" type="checkbox"/>
<b>ADVANCED FUNCTIONS</b>		
Display consumption time, software version & battery level	<input checked="" type="checkbox"/>	<input checked="" type="checkbox"/>
Reset to initial default settings function	<input checked="" type="checkbox"/>	<input checked="" type="checkbox"/>
<b>APPLICABLE REGULATIONS</b>		
CE & ROHS	<input checked="" type="checkbox"/>	<input checked="" type="checkbox"/>
EAN CODE	8436045914286	8436045914569
T.P.	£ 135.00	£ 150.00

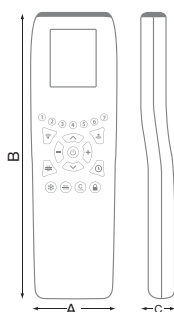

## Accessories

### wall bracket

The Rointe AIR Control remote includes a transparent, stylish and modern wall bracket.

incorporated  not incorporated  optional  not available / not applicable

# Security accessories

## Protective grill, support tripod and towel rails accessories



### Protective grill for D Series radiators

MODELS	WHITE	RDW0550	RDW0770	RDW0990	RDW1210	RDW1430	RDW1600
	GRAPHITE	RDB0550	RDB0770	RDB0990	RDB1210	RDB1430	RDB1600
Compatible with		DIW0330RAD DIW0550RAD	DIW0770RAD	DIW0990RAD	DIW1210RAD	DIW1430RAD	DIW1600RAD
		DIB0330RAD DIB0550RAD	DIB0770RAD	DIB0990RAD	DIB1210RAD	DIB1430RAD	DIB1600RAD
<b>DIMENSIONS</b>							
A (mm) - Width		600	760	920	1,090	1,260	1,410
B (mm) - Height		660	660	660	660	660	660
C (mm) - Depth		150	150	150	150	150	150
<b>MECHANICAL CHARACTERISTICS</b>							
Weight (Kg)		8.1	9	10.6	11.8	13.1	14.4
Finishes White RAL 9010 / Graphite forge effect							
EAN CODE	WHITE	8436045915993	8436045916006	8436045916013	8436045916020	8436045916037	8436045916044
	GRAPHITE	8436045916891	8436045916907	8436045916914	8436045916921	8436045916938	8436045916945
T.P.	WHITE	£ 97.00	£ 107.00	£ 118.00	£ 131.00	£ 143.00	£ 145.00
	GRAPHITE	£ 103.00	£ 113.00	£ 125.00	£ 139.00	£ 152.00	£ 154.00

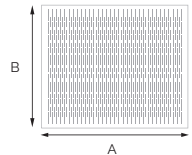

### Support tripod for Rointe water heaters

The support tripod kit consists of an easily assembled metal tripod, designed primarily because of the high weight of the 150 and 200 litre models. Installation is particularly recommended for these models where the wall brackets are not sufficient or does not ensure product stability, as these models have a high weight when they are at 100% capacity. The tripod is designed to support up to 260 kgs ideal for the larger models. The use of this support does not exempt from mandatory fixing of the water heater to the wall as described in the instructions manual.

MODEL	TPKW001
<b>COMPONENTS</b>	
Legs (pcs)	3
Braces (pcs)	6
Plastic base (pcs)	3
<b>CHARACTERISTICS</b>	
Material	Metallic
Finish	White RAL 9016
Maximum supported weight (kg)	260
<b>DIMENSIONS</b>	
A (mm) - Height	625
B (mm) - Width	530
EAN CODE	8436045914323
<b>T.P.</b>	<b>£ 80.00</b>

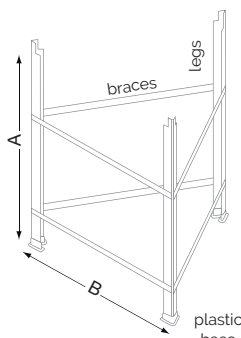

### Towel-rails accessories

MODELS	WHITE CHROME BLACK	SHELF	HANGER
		RSRW002	RSHW002
		RSRC002	RSHC002
<b>DIMENSIONS</b>			
A (mm) - Width		410	35
B (mm) - Depth		150	70
Inner tube diameter (mm)		16	×
Outer tube diameter (mm)		22	×
<b>CHARACTERISTICS</b>			
Material		Steel	Steel
Finishes	White	RAL 9016	RAL 9016
	Chrome	Chrome	Chrome
	Black	Black forge effect	Black forge effect
Max. weight supported (Kg)		2	1
EAN CODE	WHITE	8436045917041	8436045917089
	CHROME	8436045917065	8436045917102
	BLACK	8436045917058	8436045917096
T.P.	WHITE	£ 60.00	£ 25.00
	CHROME	£ 65.00	£ 30.00
	BLACK	£ 65.00	£ 30.00

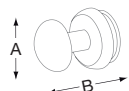
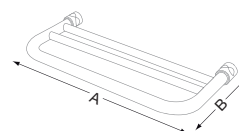

● incorporated ○ not incorporated □ optional × not available / not applicable



# Accessories for Rointe water heaters

## Energy saving & installation kits

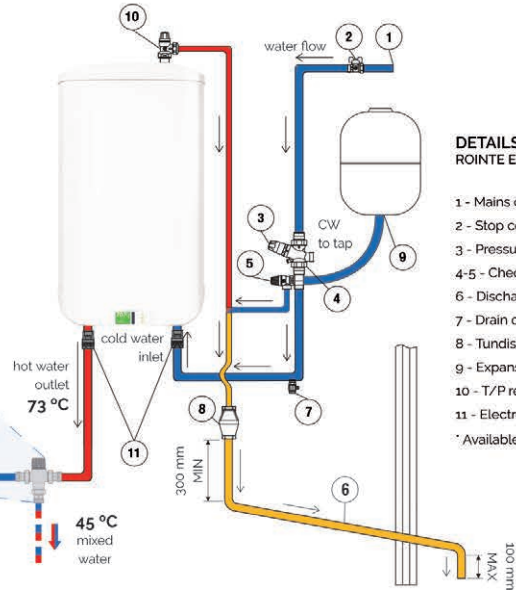
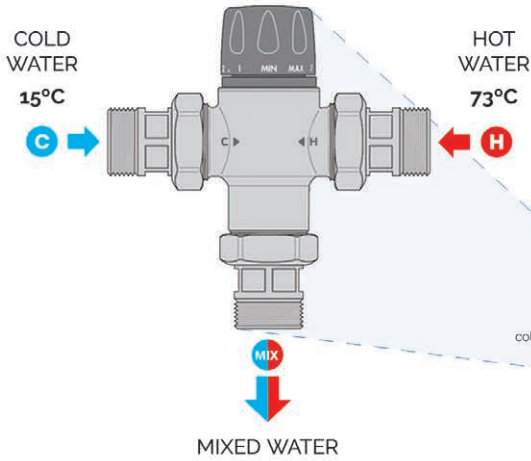

DETAILS OF THE INSTALLATION KIT  
ROINTE ELECTRIC WATER HEATERS

- 1 - Mains cold water supply
  - 2 - Stop cock (not supplied)
  - 3 - Pressure reducing valve\*
  - 4-5 - Check valve - Expansion relief valve\*
  - 6 - Discharge pipe 22 mm
  - 7 - Drain cock (not supplied)
  - 8 - Tundish\*
  - 9 - Expansion vessel\*
  - 10 - T/P relief valve (included)
  - 11 - Electrolytic fittings (included)
- \* Available in Rointe Installation Kit

### Energy saving kit

Rointe has an energy saving kit which consists of a mixing valve installed at the water heaters' hot water outlet. This valve mixes the hot water from the Rointe heater with cold water from the mains delivering thermally mixed water at your desired temperature to the point of use.

This energy saving kit saves energy by minimizing heat loss through the pipes due to transporting water at a lower temperature minimizing heat loss through the pipework.

Another advantage of this kit is the increased volume of hot water available in respect to the installed heat capacity. This amount of water is defined as equivalent volume. This represents the available volume of water at 45°C (in litres), assuming the cold water inlet temperature is 15°C and the hot water from the heater is 73°C.

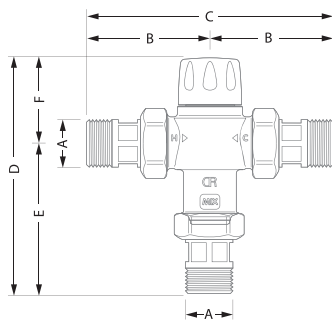

MODELS	Volume (L)	Volume equivalent to 45°C (L)
DWI050DHW2	50	86
DWI075DHW2	75	133
DWI100DHW2	100	177
DWI150DHW2	150	266
DWI200DHW2	200	354

### Installation kit

There are three kits available, depending of the size of the model. Its installation **is mandatory for all models of unvented domestic hot water heaters in the UK.**

MODELS	KITKW01	KITKW02	KITKW03
Compatible with	50 / 100 L	100 / 150 L	200 L
<b>CHARACTERISTICS</b>			
Expansion vessel	8 litres (0.1 Mpa)	12 litres (0.1 Mpa)	18 litres (0.1 Mpa)
Tundish	15 - 25 mm	15 - 25 mm	15 - 25 mm
Pressure reducing valve	0.35 Mpa	0.35 Mpa	0.35 Mpa
Relief valve	0.60 Mpa	0.60 Mpa	0.60 Mpa
<b>EAN CODE</b>	8436045914330	8436045914347	8436045914354
<b>T.P.</b>	<b>£ 218.00</b>	<b>£ 219.00</b>	<b>£ 227.00</b>

MODELS	KWVAL1814	KWVAL1815
<b>CHARACTERISTICS</b>		
Adjustment range	30÷50°C	
Accuracy	± 2°C	
Maximum working pressure (static)	10 bar	
Maximum working pressure (dynamic)	5 bar	
Temp maximum input	85°C	
Input Temp advised to avoid limescale	≤ 65°C	
Relationship max. between inlet pressures (C / F or F / C)	2:1	
Min. Temp. dif. betw. hot water inlet & mixed water outlet (to avoid burns)	15°C	
Min. flow rate to ensure stable temperature	4 l/min	6 l/min
Connections	1/2" Male	3/4" Male
<b>DIMENSIONS</b>		
A (inch)	1/2"	3/4"
B (mm)	62.5	67
C (mm)	125	134
D (mm)	126.5	127
E (mm)	81.5	82
F (mm)	45	45
<b>MATERIALS</b>		
Body: chrome alloy anti rust	EN 12165 CW602N	
Shutter	PSU	
Springs	stainless steel	
<b>INSTALLATION</b>		
Hot and cold water valves with entry filters	●	●
<b>SECURITY</b>		
Scalad & regulation locking nut protection	●	●
Temperature adjustment with hexagon screw top	●	●
<b>CERTIFICATIONS</b>		
Standard NF 079	●	●
<b>EAN CODE</b>	8436045914361	8436045914378
<b>T.P.</b>	<b>£ 150.00</b>	<b>£ 180.00</b>

● incorporated ○ not incorporated □ optional × not available / not applicable

# Rointe Thermal Coefficient (R.T.C.) and sizing

The **Rointe Thermal Coefficient** (RTC) is a coefficient developed by Rointe that serves to relate the number of elements necessary for a room with its floor area and the geographical area where it is located. With the correct sizing and using the right RTC, we will obtain a consistent consumption and effective power that is below the nominal power of the installation.

$$\frac{\text{CLIMATE ZONE RATE}}{\text{OUTPUT COEFFICIENT PER ELEMENT}} = \text{R.T.C.}$$

To calculate the necessary radiators, we have to distinguish between m<sup>2</sup> and m<sup>3</sup>. For ceilings with a height less than 3 metres, we use the RTC (m<sup>2</sup>) and for higher ceilings RTC (m<sup>3</sup>).

$$\text{R.T.C.} \times \text{m}^2 = \text{ELEMENTS NEEDED}$$

$$\text{R.T.C.} \times \text{m}^3 = \text{ELEMENTS NEEDED}$$

Climate	Climatic Coefficient		Ceiling height less than 3 m	Ceiling height more than 3 m
	BTU/h m <sup>2</sup>	BTU/h m <sup>3</sup>	R.T.C. (m <sup>2</sup> )	R.T.C. (m <sup>3</sup> )
Mild	436 BTU/h m <sup>2</sup>	139 BTU/h m <sup>3</sup>	0.75 elm./m <sup>2</sup>	0.23 elm./m <sup>3</sup>
Cold	476 BTU/h m <sup>2</sup>	159 BTU/h m <sup>3</sup>	0.80 elm./m <sup>2</sup>	0.26 elm./m <sup>3</sup>
Very cold	516 BTU/h m <sup>2</sup>	179 BTU/h m <sup>3</sup>	0.85 elm./m <sup>2</sup>	0.30 elm./m <sup>3</sup>
Extra Cold	556 BTU/h m	198 BTU/h m <sup>3</sup>	0.90 elm./m <sup>2</sup>	0.33 elm./m <sup>3</sup>

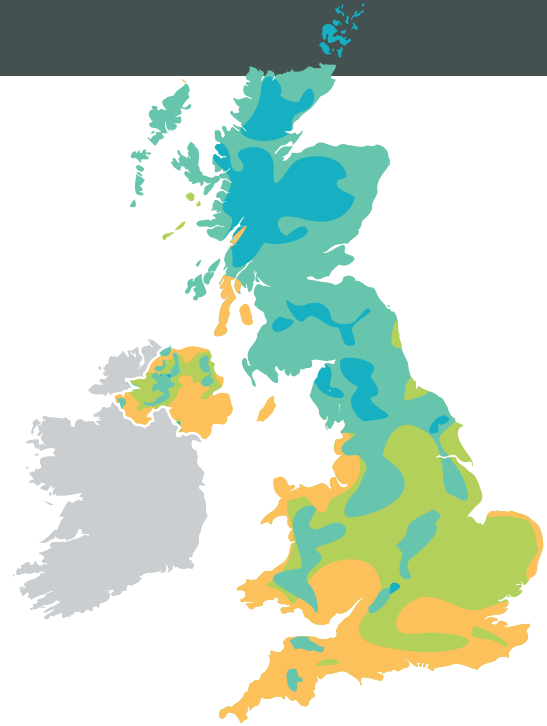

For example, if we want to obtain the R.T.C. of a cold zone...

$$\frac{476 \text{ BTU/h m}^2}{595 \text{ BTU/h m}^3} = 0.80 \text{ elements/m}^2$$

## Sizing D Series radiators: reference tables

In the following tables you can find examples of calculations already made showing number of elements, room area and climate zone.

M<sup>2</sup> - Ceiling height lower than 3 meters

Climate	MILD	COLD	VERY COLD	EXTRA COLD
BTU/h m <sup>2</sup>	436 BTU/h m <sup>2</sup>	476 BTU/h m <sup>2</sup>	516 BTU/h m <sup>2</sup>	556 BTU/h m <sup>2</sup>
R.T.C.	0.75 elm. / m <sup>2</sup>	0.80 elm. / m <sup>2</sup>	0.85 elm. / m <sup>2</sup>	0.90 elm. / m <sup>2</sup>
3 ele.	Up to 4 m <sup>2</sup>	Up to 4 m <sup>2</sup>	Up to 4 m <sup>2</sup>	Up to 3 m <sup>2</sup>
5 ele.	Up to 7 m <sup>2</sup>	Up to 6 m <sup>2</sup>	Up to 6 m <sup>2</sup>	Up to 6 m <sup>2</sup>
7 ele.	Up to 10 m <sup>2</sup>	Up to 9 m <sup>2</sup>	Up to 8 m <sup>2</sup>	Up to 8 m <sup>2</sup>
9 ele.	Up to 12 m <sup>2</sup>	Up to 11 m <sup>2</sup>	Up to 11 m <sup>2</sup>	Up to 10 m <sup>2</sup>
11 ele.	Up to 15 m <sup>2</sup>	Up to 14 m <sup>2</sup>	Up to 13 m <sup>2</sup>	Up to 12 m <sup>2</sup>
13 ele.	Up to 18 m <sup>2</sup>	Up to 16 m <sup>2</sup>	Up to 15 m <sup>2</sup>	Up to 15 m <sup>2</sup>
15 ele.	Up to 20 m <sup>2</sup>	Up to 19 m <sup>2</sup>	Up to 18 m <sup>2</sup>	Up to 17 m <sup>2</sup>

M<sup>3</sup> - Ceiling height higher than 3 meters

Climate	MILD	COLD	VERY COLD	EXTRA COLD
BTU/h m <sup>3</sup>	139 BTU/h m <sup>3</sup>	159 BTU/h m <sup>3</sup>	179 BTU/h m <sup>3</sup>	198 BTU/h m <sup>3</sup>
R.T.C.	0.23 elm. / m <sup>3</sup>	0.26 elm. / m <sup>3</sup>	0.30 elm. / m <sup>3</sup>	0.33 elm. / m <sup>3</sup>
3 ele.	Up to 15 m <sup>3</sup>	Up to 13 m <sup>3</sup>	Up to 11 m <sup>3</sup>	Up to 10 m <sup>3</sup>
5 ele.	Up to 23 m <sup>3</sup>	Up to 21 m <sup>3</sup>	Up to 18 m <sup>3</sup>	Up to 16 m <sup>3</sup>
7 ele.	Up to 32 m <sup>3</sup>	Up to 28 m <sup>3</sup>	Up to 25 m <sup>3</sup>	Up to 22 m <sup>3</sup>
9 ele.	Up to 41 m <sup>3</sup>	Up to 36 m <sup>3</sup>	Up to 31 m <sup>3</sup>	Up to 28 m <sup>3</sup>
11 ele.	Up to 50 m <sup>3</sup>	Up to 44 m <sup>3</sup>	Up to 38 m <sup>3</sup>	Up to 34 m <sup>3</sup>
13 ele.	Up to 58 m <sup>3</sup>	Up to 51 m <sup>3</sup>	Up to 45 m <sup>3</sup>	Up to 40 m <sup>3</sup>
15 ele.	Up to 67 m <sup>3</sup>	Up to 59 m <sup>3</sup>	Up to 51 m <sup>3</sup>	Up to 46 m <sup>3</sup>

Water heater recommended according to use & number of people

SIZE	USERS	USE
50 L	1-2	Laundry / Sink / Shower
75 L	2-4	Laundry / Sink / Shower
100 L	2-5	Laundry / Sink / Small Bath
150 / 200 L	3-6	Laundry / Sink / Shower / Small Bath

Towel rails recommended by area

AREA	POWER	SERIES	MODEL
Up to 3 m <sup>2</sup>	300 W	D Series White/	DTI030SEW/SEB/SER
Up to 5 m <sup>2</sup>	450 W		DTI045SEW/SEB/SER
Up to 7 m <sup>2</sup>	600 W	Graphite/ RAL Colour	DTI060SEW/SEB/SER
Up to 10 m <sup>2</sup>	750 W		DTI075SEW/SEB/SER
Up to 2 m <sup>2</sup>	300 W	D Series Chrome	DTI030SEC
Up to 4 m <sup>2</sup>	300 W		DTI045SEC
Up to 6 m <sup>2</sup>	450 W		DTI060SEC
Up to 8 m <sup>2</sup>	600 W		DTI075SEC



# Calculation example

## for a household of 80 m<sup>2</sup> in cold climate zone

Estimated calculation for an 80m<sup>2</sup> dwelling located within a cold area of the UK providing 12 hours/day-night maintaining the radiators' set temperature at 21°C.

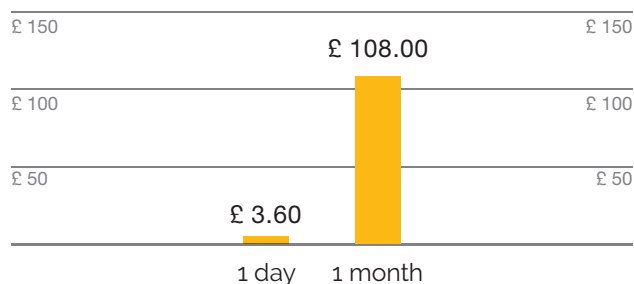

### Installation recommendations

In the case of stairs and corridors there is a high risk of heat loss, so it is recommended to increase the result of the calculations by 15%.

For kitchens, being areas with furniture and a much higher general temperature, we can reduce the output by as much as 10%.

Avoid placing obstacles near radiators and distribute them in a balanced way. For example, if a room of 21 m<sup>2</sup> need 18 elements, ideally fit 2 radiators 9 elements each.



Sample calculation in m<sup>2</sup> (ceiling height less than 3 metres), well insulated and double glazed.

ROOM	M <sup>2</sup>	RTC	N° OF ELEMENTS	PRODUCTS	NOM. POWER	CONSUMPTION COEFFICIENT RATIO	EFF. POWER
Living room	19	0.80	15	1 X DIW1600RAD	1,600 W	38%	608.00 W
Kitchen	14	0.80	11	1 X DIW1210RAD	1,210 W	38%	459.80 W
Hall	9	0.80	7	1 X DIW0770RAD	770 W	38%	292.60 W
Bathroom	6	0.80	5	1 X DIW0550RAD	550 W	38%	209.00 W
Bedroom 1	14	0.80	11	1 X DIW1210RAD	1,210 W	38%	459.80 W
Bedroom 2	9	0.80	7	1 X DIW0770RAD	770 W	38%	292.60 W
Bedroom 3	9	0.80	7	1 X DIW0770RAD	770 W	38%	292.60 W
80 m <sup>2</sup>			63	7	6,880 W	38%	2,614.40 W

D Series radiator : calculation of effective power

#### Calculation of effective power

NOMINAL POWER	EQ. RATIO OF CONSUMPTION	EFFECTIVE POWER
6,880 W	38%	2.61 KW

The Rointe D Series radiator to maintain a stable temperature of 21°C for 12 hours just needs an equivalent ratio of consumption of only the 38% of its nominal power.

#### Calculating the daily / monthly cost

EFFECTIVE POWER	HOURS OF HEATING	UNIT RATE	DAILY COST	MONTHLY COST
2.61 KW	12 h	£ 0.115	£ 3.60	£ 108.00

Remember that these are estimates and should be considered as an average. It is mandatory that a personalised study is carried out by a Rointe qualified installer or the Rointe technical team.

# Terms and conditions of sale

## 1. DEFINITIONS

"Company" means ROINTE UK.

"Customer" means any person or organisation to whom the Company shall provide or contract to provide Goods.

"Goods" means goods sold by the Company to the Customer and including but not limited to those goods for which payment in full has not been received by the Company.

"Contract" means the Contract between the Company and the Customer for the sale of Goods.

## 2. GENERAL APPLICATION

2.1. These conditions apply to all Goods supplied by the Company to the Customer and no alteration or qualification of these conditions shall be effective unless agreed by the Company in writing. No order shall be binding on the Company until accepted by the Company in writing.

2.2. The Customer who orders Goods from the Company shall be deemed to agree that any written or printed conditions attached to or referred to in such orders are only binding so far as they are not at variance with the Company's Terms and Conditions.

2.3. The Customer acknowledges these terms and conditions of sale having checked them in advanced and accepting them in full. (CTD16V1-UK)

## 3. PRICE AND PAYMENT

3.1. All Goods must be paid for at the time of ordering unless the Company has agreed to supply on credit terms in which case the following conditions apply:

- a. Payment shall be due as per the invoice.
- b. Payment shall be made in full without deduction or set off.
- c. The Customer shall indemnify the Company in respect of all costs incurred by the Company in recovery of the price from the Customer.
- d. Payment may not be delayed under any circumstances.

3.2. Prices are subject to revision without notice and the prices payable by the Customer will be those in effect at the date of order.

3.3. Prices quoted in current price lists of the Company supersede all prices for similar goods in previous price lists.

3.4. Prices quoted are exclusive of V.A.T. which shall be charged at the rate applicable at the time.

## 4. CANCELLATION

4.1. No cancellation of any order from the Customer can be accepted without prior written agreement from the Company. If the Company provides written agreement to the cancellation any and all costs and expenses incurred by the Company will be paid by the Customer.

4.2. No cancellation of orders will be accepted under the following circumstances:

- a. If the order has been dispatched.
- b. If the order contains special units whose manufacturing has begun.

## 5. CUSTOMER RETURNS IN GOOD CONDITION

5.1. No customer returns can be accepted without prior written agreement from Rointe..

5.2. A handling charge of at least 15% of the original cost price will be payable to cover receipt, inspection and fault registration costs.

5.3. All carriage charges relating to returns made to Rointe are at the customers cost.

5.4. Any non-faulty product returned by the customer will only be accepted under the following conditions:

- a. Goods returned for credit in less than 30 days from date of purchase will incur a 15% handling charge.
- b. Goods returned for credit between 30 days and 3 months from date of purchase will incur a 20% handling charge.
- c. Goods returned for credit between 3 months and 12 months from date of purchase will incur a 25% handling charge.
- d. Goods returned for credit that were purchased over 12 months will incur a 30% handling charge.

## 6. DELIVERY

6.1. All times or dates given for the delivery of the Goods are approximate only and the Company shall not be liable for any delay in delivery of the goods howsoever caused.

6.2. The Company shall be entitled to delay or cancel delivery or to reduce the amount delivered if it is prevented from or delayed in manufacturing, obtaining or delivering the Goods through any circumstances beyond its control including but not limited to strikes, lockouts, accidents, war, fire, reduction in or unavailability of power at manufacturing plant, breakdown of plant or machinery or shortage of or unavailability of raw materials from normal sources of supply.

6.3. Minimum carriage paid: £1,000 net (excluding VAT). For less than this total amount there is a £30 carriage fee.

6.4. Next day orders will be £30. Next day delivery before 12.00 a.m. is £40. Next day delivery before 10.00 a.m. is £50. Saturday a.m. is £60. Spares, remote controls and grills are £5.

6.5. The Company reserves the right not to supply if the Customer has outstanding invoices and the payment is overdue. The customer in this case will be on stop.

## 7. DELIVERY CONDITIONS

7.1. The products are supplied packaged with brackets, screws and fixings the cost of which is included in the sale price. The goods are deemed to be delivered when they are placed on the lorry in the warehouses, except for offers with special conditions, and the Company's liability as a haulier ends at that point.

7.2. Confirmed orders may be supplied in partial deliveries. The Customer should check the goods and write "received pending checking" next to the signature in the haulier's delivery note.

## 8. GUARANTEE

8.1. All the materials are covered by the respective guarantees for any manufacturing faulty from the date of sale and acceptance of the fault by our Technical department will be required before the faulty product is returned to us. Please refer to our brochure to check all details.

## 9. DEBIT NOTES

9.1. The Company reserves the right not to accept debit notes received by the Customer.

9.2. No debit note from the Customer can be accepted without prior written agreement of the Company and the Company provides written agreement to process the debit note accordingly.

**10. RISK AND TITLE**

- 10.1. Risk in respect of any Goods connected with the Contract shall pass to the Customer at the time of delivery by the Company.
- 10.2. Title to the Goods shall not pass to the Customer until the Customer has paid the total price to the Company.
- 10.3. The Customer is not the agent of the Company for the purposes of any sale of the Goods and for the avoidance of doubt it is hereby declared that on no account has the Customer or its receiver or liquidator or trustee in bankruptcy any authority to sell the Goods when in receivership liquidation or bankruptcy or when the same is about to occur.

**11. EXCLUSION OF LIABILITY**

- 11.1. Except in respect of death or personal injury caused by the negligence of the Company or its agents, officials or employees (being negligence defined by Section 1 of the Unfair Contract Terms Act 1977) the Company shall not be liable to the Customer by reason of any representation implied warranty condition or other term or any duty at common law or under any contract or for any economic loss, loss of production, loss of bargain, loss of profit or any other costs expenses or other claims for consequential compensation whatsoever which arise out of or in connection with the Contract except as expressly provided in these conditions and PROVIDED ALWAYS that the maximum liability of the Company in relation to any loss or damage shall in no case exceed the price in the Contract.

**12. REPRESENTATIONS**

- 12.1. The Company's employees or agents are not authorized to make any representations concerning the Goods unless confirmed by the Company in writing.

**13. SHORTAGES**

- 13.1. Shortages should be identified at the time of delivery and noted on the face of proof of delivery document which should be signed by the Customer indicating acceptance of the delivery as specified or amended.
- 13.2. Failure to note alleged shortages at the time of delivery shall prevent the Customer from claiming under the Contract.
- 13.3. The customer cannot claim compensation under any circumstances.

**14. BRITISH STANDARD**

- 14.1. The Goods shall be supplied by the Company in accordance with the relevant British standard applying to such Goods.

**15. WARRANTY**

- 15.1. Where any Goods (or any part thereof) are shown to the reasonable satisfaction of the Company to be defective by reason of faulty material or workmanship within a period of twelve months from the date of installation in respect of domestic heaters or water heaters or twelve months from the date of delivery in the case of Goods supplied for use in homes or professional areas the Company shall at its sole option:

- a. Deliver replacement Goods or any part or parts thereof free of charge.
- b. The liability of the Company under these terms and conditions shall be accepted by the Customer in substitution for and to the exclusion of any other claims for direct loss which the Customer has or may have.
- c. The Customer should revise the instructions manual and bear in mind the Company recommendations.

**16. HEALTH AND SAFETY**

- 16.1. All Goods are supplied by the Company to the Customer with appropriate fitting and other instructions relating to the fitting and installation of Goods. Certain goods are supplied accompanied by written recommendation from the Company that they should only be fitted or installed by expert and skilled workers and it shall be the responsibility of the Customer to ensure that where the Goods are sold on to a third party they are accompanied by all appropriate safety and fitting instructions.

- 16.2. Where the Customer fits and installs the Goods itself it shall ensure that the contents of all the safety and fitting instructions are specifically drawn to the attention of its employees.

- 16.3. The Customer hereby undertakes to take such measures as are communicated in writing to the Customer by the Company and to take such other steps which are sufficient to ensure, so far as is reasonably practicable, that the Goods will at all times be safe and without risk to health when properly used. The Goods shall not be regarded as properly used when they are used without regard to any relevant information or advice relating to their use which is communicated to the Customer by the Company.

- 16.4. The Customer shall indemnify and keep indemnified the Company in respect of all claims, actions, proceedings, costs, expenses, loss or damage (whether direct, indirect, economic or consequential) including without prejudice to the generality hereof any monetary penalty or fine in respect of or in connection with the Goods arising out of any one or more of the following:

- a. under the Health and Safety at work Act 1974 as amended or any regulations orders or directions made thereunder.
- b. Resulting from any breach of the Customer's obligations under this terms and conditions.
- c. Under the Consumer Protection Act 1987 or any statutory replacement therefor in respect of Goods which were not defective at the time when they were supplied to the Customer.

**17. SEVERANCE**

- 17.1. In the event that for any reason any provision or provisions in these conditions or any part thereof is or is held to be void or unenforceable or otherwise invalid any Contract made which incorporates these conditions shall continue to be fully binding and the remainder of these conditions shall continue to be effective.

**18. WAIVER**

- 18.1. The rights and remedies of the Company under the Contract shall not be diminished waived or extinguished by the granting of any indulgence, forbearance or extension of time by the Company nor by any failure of or delay by the Company in asserting or exercising any such right or remedy.

**19. JURISDICTION**

- 19.1. The conditions in each and every Contract made pursuant hereto here shall be governed by and construed in all respects in accordance with the Laws of England and the Company and the Customer irrevocably submits to the exclusive jurisdiction of the English Courts.

- 19.2. These general terms of sale will apply to all trade relations between the Company and the Customers, and purchases accept these general conditions when making an order.



**Rointe United Kingdom & Éire**  
Catalyst House, 720 Centennial Court,  
Centennial Park, Elstree, Herts, WD6 3SY

T. 01432 598 019  
F. 0208 953 5861

www.rointe.co.uk  
rointe@rointe.co.uk

**Rointe España y Portugal**  
Pl. Vicente Antolíns  
C/ E. parc. 43. 30140 Santomera, Murcia

T. 902 158 049  
F. 968 277 125

www.rointe.com  
rointe@rointe.com

**Rointe France**  
6 Rue Duret,  
75116 Paris

T. 01 73 05 70 01

www.rointe.fr  
rointe@rointe.fr



## Discover the new Rointe Calculation App

Enter [www.rointecal.com](http://www.rointecal.com)  
and generate your own technical  
studies easily.\*

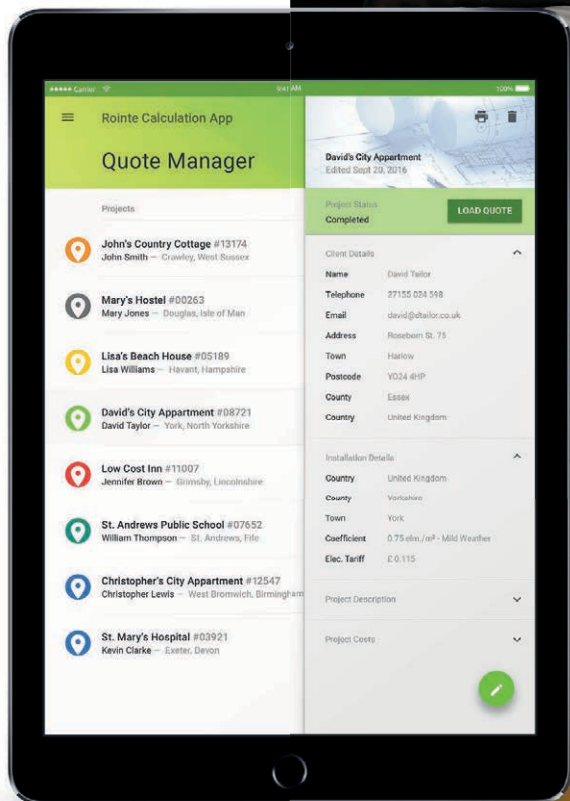

CTD16V1-UK

\*These technical studies are considered as a sample and not valid for an Official Rointe products installation. The only technical study valid and recognised as an official is the one done by the Rointe Projects Team. Send us the details to [sales@rointe.co.uk](mailto:sales@rointe.co.uk) and get your free, personal and valid technical study.