



**EH1896**



**2kW Overdoor Heater**

**IMPORTANT  
INSTALLER AND USERS PLEASE NOTE:**

These instructions should be read carefully and left with the user of the product for future reference. This product is only suitable for well insulated spaces or occasional use.

**BEFORE USE**

You must inspect the appliance including its cable and plug for any signs of damage. If the product is damaged, DO NOT use it, and contact your supplier immediately.

**PRODUCT SAFETY**

- This appliance can be used by children aged from 8 years and above and persons with reduced physical, sensory or mental capabilities or lack of experience and knowledge if they have been given supervision or instruction concerning use of the appliance in a safe way and understand the hazards involved.
- In order to avoid a hazard due to inadvertent resetting of the thermal cut-out, this appliance must not be supplied through an external switching device, such as a timer, or connected to a circuit that is regularly switched on/off by the utility.
- The heater must be installed at least 1.8m above the floor.
- Children shall not play with the appliance.
- Cleaning and user maintenance shall not be made by children without supervision.
- Do not cover the heater.
- For indoor use only.
- Do not use in bathrooms,
- Do not use in wet or damp locations.
- Do not place the mains lead beneath a carpet or rug.
- Do not position heater immediately below a socket outlet.
- Before using please ensure the intended socket / electrical outlet matches the recommended rating issued to the heater.
- Do not use the heater in locations where paint, petrol or other flammable liquids are used or stored.
- Please ensure heater is switched off and unplugged when not in use
- Please do not use an extension lead with this heater as this could cause the product to overheat.
- If the fan stops running, the appliance should be turned off immediately
- Do not use the heater for other than its intended use.
- Do not insert any object into the heater through the grilles. This may damage the heater or result in overheating or electric shock.
- There must be a minimum 300mm safe area above and around the sides of the heater, clear of obstructions
- Do not obstruct the air intakes of this heater.

## INSTALLATION

This product must only be fitted by a competent person and after a site survey has been conducted to assess the suitability of the structure this product will be fitted to. This product must be fitted using appropriate fixings to a flat, vertical wall.

Primary fixing point holes must be positioned at a distance of 385mm apart and at least 1.87m from the floor (the base of the unit must be at least 1.8m from the floor).

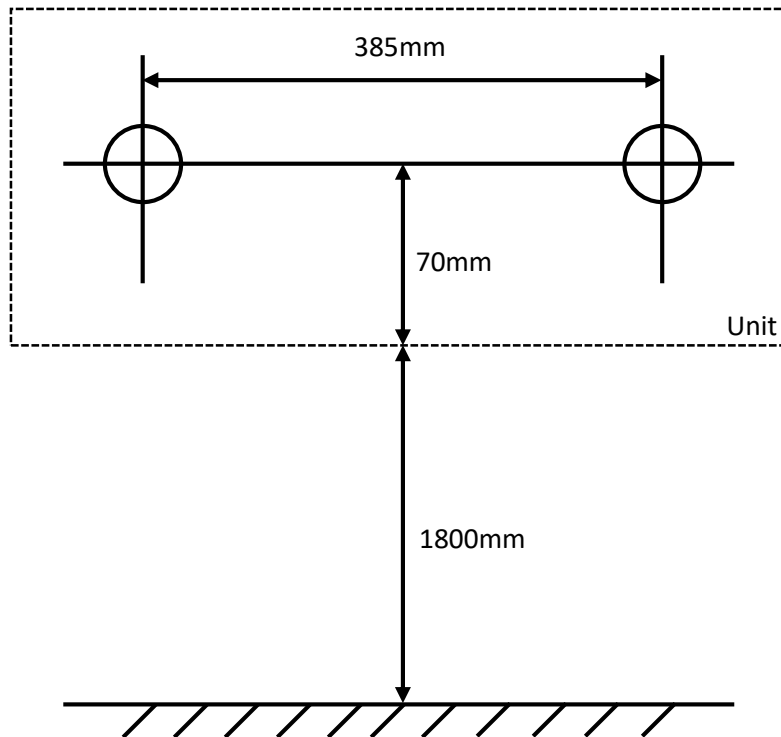

Secondary fixing point hole must be located centrally and below the unit, to align with the secondary fixing point bracket.



Secondary Fixing Point

The unit will need to be hung on the primary fixing points first, then mechanically fixed through the secondary fixing point. The unit must not be operated unless all fixing points are fully secured.

## OPERATION

Note: When heaters are turned on for the first time, or when they are turned on after not being used for a prolonged period of time, it is normal for the heater to emit some smell or fumes. This will disappear when the heater has been on a short while. If the smell does not disappear, we advise to switch off the heater and contact a specialist.

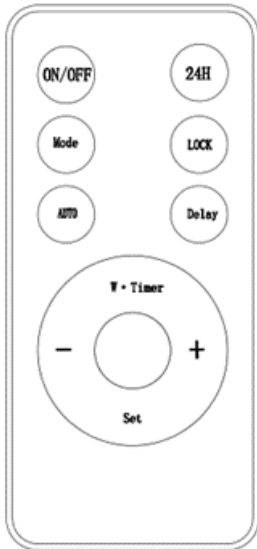

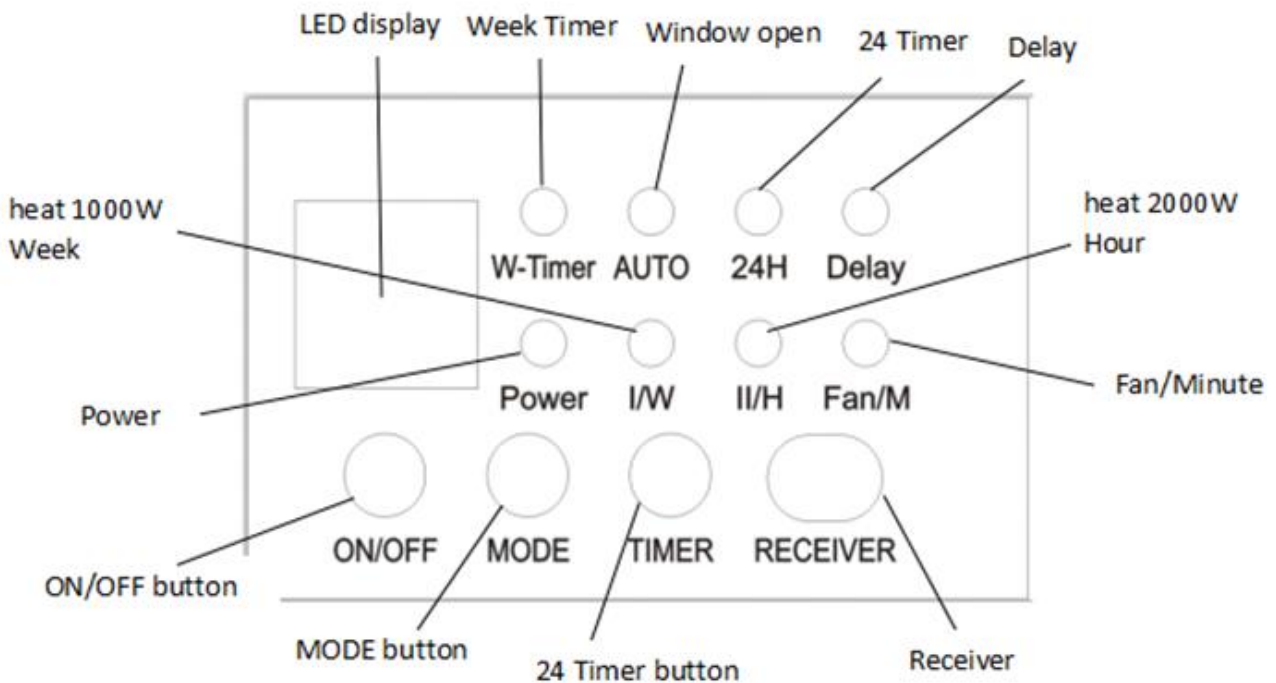

1. ON/OFF - Main power button
2. 24H - Setting timer from 1-24 hours
3. MODE - COLD,WARM,HOT 3 setting for selection
4. LOCK - Child-Lock function for heater
5. AUTO - Window Open Function
6. Delay - Set the open and closed time of heater
7. W.Timer Set the timer of one week







## Set Time

Before the unit is operated, ensure you set the correct time.

On the remote control, press  , the control panel will show the current room temperature.

**SET DAY:** press “SET” button once. I/W light will illuminate. Use   buttons to set the day from 1-7 (1=Monday, 2=Tuesday...7=Sunday).

**SET HOUR:** press “SET” button again. II/W light will illuminate. Use   buttons to set the hour from 01-00

**SET MINUTE:** press “SET” button again. FAN/M light will illuminate. Use   buttons to set the minute from 00-59

*Note: the unit will keep the correct time until the power is disconnected.*

## Remote Control & Operation

Turn on the machine by pressing the ON/OFF button. The fan function will operate and blow cool air, the FAN/M light will illuminate.

To set to heating mode, press MODE button once, the unit will operate at half heating power and the I/W light will illuminate.

Press MODE button again to set the unit to full heating power, the II/H light will illuminate.







*Note: the unit control panel operates in the same way*

## 24 Hour Timer (delay shutdown)

The timer can be set between 1-24 hours. Press the timer button  on the remote control to set the desired operating time. The time displayed is the number of hours the unit will operate for until it goes into standby mode.

## Delay start timer









The unit can be set to switch on after a period of time and remain on for a set period of time. This function can only be programmed through the remote control.

1. With the unit in standby mode press  then  and the delay light and I/W light will illuminate. Use   to set the hours (01-24) you wish to delay the start for.
2. Press  again and the II/H light will illuminate. Use   to set how many hours you wish the unit to run for.







## Weekly Timer

The weekly timer can only be programmed through the remote control. The timer is controlled by setting the “Switch ON” and “Switch OFF” times the heater will operate. The following steps 1-5 must be completed together to set an operating window

To set the ON time:

1. **SET DAY:** press  once, I/W and W-TIMER light will illuminate, use   to choose the day to program.
2. **SET HOUR:** Press  again, II/H light will illuminate. Use   to set the start hour.
3. **SET MINUTE:** Press  again, FAN/M light will illuminate, use   to set the start minute.

to set the OFF time:

4. **SET HOUR:** press  again, II/H will illuminate, use   to set the off hour.
5. **SET MINUTE:** press  again, FAN/M will illuminate, use   to set the off minute.

*Note: the above timed operating window instructions are for 1 period in 1 day, to set another period on another day, please follow steps 1-5 again and choose the day and times accordingly.*

## Open Door/Window Function

The *open door function* is an energy saving mechanism that enables the unit to track changes in temperature and will stop the unit from operating if the thermostat registers a rapid drop in temperature of 3°C (ie, if a door or window were to be opened). The function can only be programmed from the remote.

During normal operation, select  to enable the function, the AUTO light will be illuminated. Press again to disable the function and the AUTO light will go out.

## Child Lock Function

This function can only be programmed through the remote control.

Press the  button once. All the LED lights will go out and only the power light will remain illuminated. In this mode, both the control panel and remote control are locked.

Press the  button again and the unit will return to its unlocked state.

## PAT TESTING

When used in a workplace, this product should be safety-tested yearly by a qualified electrician (PAT tested). We recommend that it is PAT tested regularly when used in a domestic environment.

## GENERAL SAFETY REQUIREMENTS

Domestic wiring must be tested periodically by a qualified electrician at least once every 10 years, or at every change of occupancy. For office and retail premises, and buildings such as village halls, the wiring must be inspected at least once every 5 years. It is recommended that all buildings be fitted with smoke alarms (it is mandatory for new buildings).

## OPERATING COSTS

At time of going to press, the average cost of electricity is £0.145 per unit (kilowatt-hour). The amount you are being charged will be shown on your electricity bill. At this cost, the EH1896 will cost £0.29 per hour to run, with the heater on full power and thermostat set to maximum. If the thermostat is used to regulate the temperature, the operating costs will be lower, depending on the room temperature and the size of the room.

## MAINTENANCE

Before cleaning, turn the heater off and disconnect from the mains supply. the heater may then be cleaned using a damp cloth with a drop of washing-up liquid to remove any dust or dirt from the case. Do not use stronger detergents or solvents as these may damage the case. Using a dry 1" (25mm) paint brush, remove any dust from the grilles. If the mains lead is damaged, it must be replaced by the manufacturer or an authorised service centre. If the mains plug needs to be replaced, proceed as follows:

- Connect the brown (live) wire to the terminal "L"
- Connect the blue (neutral) wire to the terminal "N"
- Connect the yellow and green (earth) wire to the terminal "E"

Ensure the cord grip is positioned correctly (over the outer sheath of the cable) and is fully tightened.

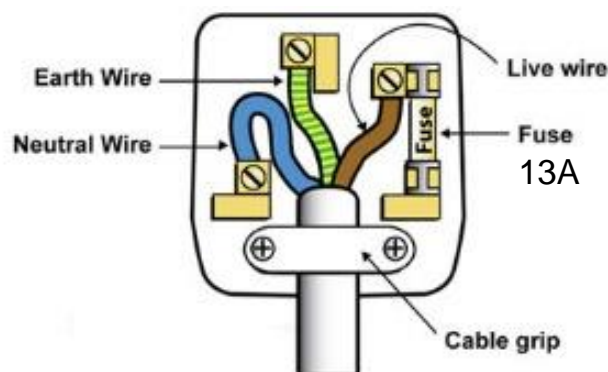



## **DISPOSAL AND RECYCLING**

You must not dispose of this appliance with domestic household waste. Most local authorities have specific collection systems for appliances and disposal is free of charge to the end user. When replacing an existing appliance with a similar new appliance, your retailer may take the old appliance for disposal.

## **TECHNICAL SPECIFICATION**

Dimensions:	247 x 645 x 158 mm
Weight:	1.7kg
Power supply:	230V ~
Power consumption:	2kW

## **SERVICE WARRANTY**

Prem-I-Air guarantees the product free from defects in materials and workmanship for a period of 1 year. Should this unit be operated under conditions other than those recommended, at voltages other than the voltage indicated on the unit, or any attempts made to service or modify the unit, then the warranty will be rendered void. The product you buy may sometimes differ slightly from illustrations. This warranty is in addition to, and does not affect, your statutory rights. If you have any problems with this product, please call our help desk on (0845) 459 4816.

### **Prem-I-Air Appliances Ltd.**

Lancots Lane  
Sutton  
St. Helens  
Merseyside  
**WA9 3EX**

**[www.prem-i-air.co.uk](http://www.prem-i-air.co.uk)**