

Instructions & installation manual

PH-21

 **heatershop**
HEATING YOUR HOME FOR LESS

www.heatershop.co.uk



01473 276686





www.haverland.com
www.haverland.co.uk

INDEX

1. Safety Notes	3
2. Assembling process	5
3. Operation	8
4. Maintenance	8
5. Guarantee	9

- Please read these instructions carefully.
- Only use the halogen heater on a firm solid horizontal area where all the feet on the base are in contact with the floor (**should the heater be tilted or fall over the auto cut off switch will activate**).
- Place the heater outside or in a large open area and well away from any obstructions such as branches or where the heater is near any objects can be affected by heat, such as furniture, curtains or other inflammable objects (minimum distance 1 meter).
- Do not use in unventilated areas.
- Do not use where gas, petrol, paint or other inflammable goods are stored.
- Do not push any items through, obstruct or cover the grill of the heater head.
- Do not leave turned on and unattended especially when children and or animals are in the vicinity.
- The indication of the different positions of the switches shall be visible from a distance of 1m.
- The unit must be securely placed on a horizontal and flat surface.
-  **DANGER:** The unit is at a high temperature during operation. It stays hot for a while after switching off. Potential danger can occur when touching it during this period.
-  **DANGER:** Don't place the unit close to a curtain and/ or other flammable objects. Otherwise there will be danger of catching fire.
-  **DANGER:** Don't cover the unit with anything during operation or a short time after it's been switched off.
- Don't wrap the power supply cord around the unit.
- The unit must be handled with care, and avoid vibration or knocking.
- The unit must be securely grounded during operation.
- When assembling, keep clear from any board or flammable

material.

- The head of the unit is at high temperature during operation.
- Unplug the unit and wait till it cools before cleaning.
- Don't use this unit in a place where causticity or volatile air exists, i.e. dust, steam, gas, etc.
-  **IMPORTANT:** Do not use this unit to dry clothes or towels.
- Don't use this unit as a sauna heater.
- Don't use this unit hatcheries.
- Don't immerse this unit into water to clean it.
- The unit should be plugged in a socket, which is easily visible and reachable.
- Dark points may exist on the surface of the heating elements during the first few minutes after it is turned on. This is normal, and will not affect the performance of the unit.
- Children less than 3 years old should be kept away unless continuously supervised.
- Children from 3 to 8 years old shall only switch on/off the appliance provided that it has been placed or installed in its intended normal operating position and they have been given supervision or instruction concerning use of the appliance in a safe way and understand the hazards involved. Children between 3 and 8 years old shall not plug in, regulate and clean the appliance or perform user maintenance.
-  **CAUTION:** Some parts of this product can become very hot and cause burns.
- Particular attention has to be given where children and vulnerable people are present.
- The warranty of the radiator does not cover any damage caused by failing to read these instructions.

2. ASSEMBLING PROCESS

1 Step 1: Screw the bottom tube onto the base.

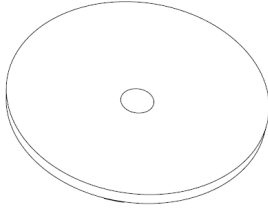

Fig. 1

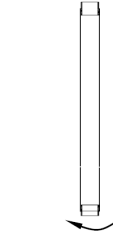

Fig. 2

2 Step 2: Screw the middle tube with the bottom tube.

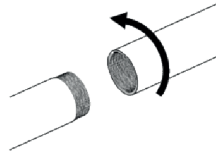

Fig. 3

3 Step 3: Feed the Power Cord through the Base and the Bottom Tube, middle tube, and pull through around 2m of cable.

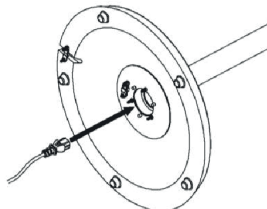

Fig. 4

4

Step 4: Place the power cord plug through the base, bottom pole, middle pole and top pole. Connect the power cord plug to the socket in the heater head.

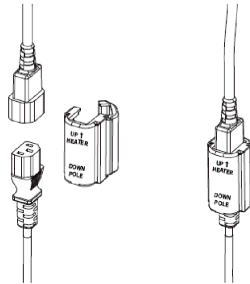

Fig. 5

5

Step 5: Fit the heater head to the top hollow tube and fix it in position using the supplied 2 X M4*8 screws.

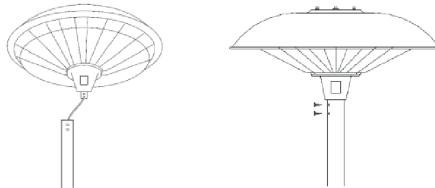

Fig. 6

6

Step 6: Pull the power cord gently out of the base as much as possible. Fix the power cord under the weighted base using the supplied 4pcs M4 nuts.

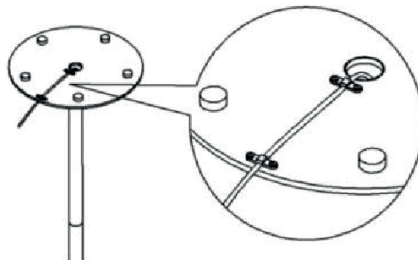

Fig. 7

7

Step 7: Extend or retract the top tube to the desired height and tighten to the middle tube by screwing down the locking ring.

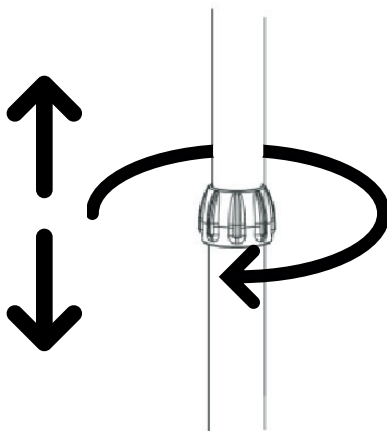

Fig. 8

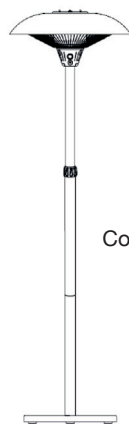

Fig. 9

3. OPERATION

Plug the Patio Heater into a grounded 220V-240V, 50-60Hz power outlet.

**IMPORTANT:**

- **The heater must be properly installed before it is used .This unit is equipped with one heat setting On I Off.**
- **Although the patio heater is waterproof, do not use when raining or in wet conditions.**
- **Only operate the heater when it is in the upright position.**
- **Always disconnect the power cable from the electrical supply, when the patio heater is not in use.**

Our Electric Patio Heater is equipped with with three power settings; 900 W, 1200 W and 2000 W.

- 1) Press the On/Off button to turn the heater on or off .
- 2) Press the button **once** to operate the heater on low (900W) power.
- 3) Press the button **twice** to operate the heater on medium (1200W) power.
- 4) Press the button **three times** to operate the heater on maximum (2100W) power.
- 5) Press the button **four times** to turn off the resistances and stop the emission of heat.

4. MAINTENANCE

- Unplug the unit and let it cool completely.
- To keep the heater clean, the outer shell must be cleaned with a soft, damp cloth. You may use a mild detergent if necessary. After cleaning, dry the unit with a soft cloth.
- **DO NOT** use alcohol, gasoline, abrasive powders, furniture polish, or rough brushes to clean the heater. This may cause damage or deterioration to the surface of the heater.
- Although this heater is outdoor approved, **DO NOT immerse the heater in water for your safety.**
- Wait until the unit is completely dry before use.
- If the heater will not be used for a long period of time, store it in a cool, dry location when not in use. To prevent dust and dirt build-up, use the original packaging to repack the unit.



NEVER USE SOLVENTS OR ABRASIVE PRODUCTS.

GUARANTEE

MARSAN INDUSTRIAL, S.A. guarantees that the devices comply with the contracted specifications.

This warranty only covers the model of heater showed on the valid invoice.

Such rectifications will be guaranteed against any manufacturing and operating defect for the normal and domestic use of this product, for a period of 24 months as from the purchase date shown on the invoice.

HAVERLAND guarantees against material, design or manufacturing faults at the moment of its original acquisition for 2 years.

This warranty only covers the device whose model appears on the purchase invoice.

This warranty DOES NOT COVER incorrect installation, maintenance, cleaning or conserving the device, and neither does it cover failures and faults due to force majeure, chemical agents or atmospheric phenomena, incorrect use of the device, the purchaser's faulty electrical installations, transporting the device or problems caused by the device being handled by persons not authorised by MARSAN INDUSTRIAL, S.A.

This warranty must not be modified, altered or extended, and the Manufacturer does not authorise anybody to act on his behalf to modify, alter or extend it.

This warranty applies only to the Product.

To repair the device, the consumer must dial the Technical Assistance Service at 0330 3651940 or send an email to haverland@haverland.co.uk and ask for the information needed about the procedure to follow:

For a replacement, cancellation or price reduction, when in order, the consumer must go the establishment where the device was purchased. This warranty does not affect the consumers' rights as established in the provisions contained In Ley 23/2003, the Consumer Goods Sales Guarantee Act.



Customer Service Telephone:
0330 3651940



E-mail: haverland@haverland.co.uk

Made in Spain

Marsan Industrial, S.A. reserves the right to modify without previous warning

Haverland UK Limited
Challengue House
Sherwood Drive
Bletchley MK3 6DP



www.heatershop.co.uk

01473 276686

PH-21

W
900 /1200 /2000

230 V 50 Hz
CLASE I / CLASS I
CLASSE I
IP 44