

RCTTC CONNECT



Manual de instalación y uso
Instructions & installation manual
Manuel d'installation et utilisation
Manual de instalação e uso



HAVERLAND
APP



Español

English

Français

Português

4	1. ADVERTENCIAS GENERALES
6	2. INSTALACIÓN
9	3. FUNCIONAMIENTO
9	3.1 PANEL DE CONTROL
9	3.2 INICIO - PRIMERA CONEXIÓN
10	3.3 MODOS DE FUNCIONAMIENTO
10	3.4 MODO OFF
11	3.5 MODO AUTO (PRO)
11	3.5.1 PROGRAMACIÓN HORARIA
12	3.5.2 PUESTA EN HORA
12	3.5.3 PROGRAMACIÓN SEMANAL
15	3.5.4 ¿CÓMO CONFIGURAR LAS TEMPERATURAS DE CONSIGNA?
17	3.6 MODO MANUAL
18	3.7 BLOQUEO DE TECLADO
18	3.8 FUNCIÓN “BOOST” - FUNCIÓN 2 HORAS
19	3.9 FUNCIÓN AHORRO “VENTANAS ABIERTAS”
19	3.10 FUNCIÓN INTELIGENTE ITCS
20	3.11 FUNCIONES AVANZADAS
21	3.12 DESCONEXIÓN RED ELÉCTRICA / CORTE SUMINISTRO
22	3.13 HAVERLAND APP
23	4. MANTENIMIENTO

24	1. GENERAL WARNINGS
26	2. INSTALLATION
29	3. OPERATION
29	3.1 CONTROL PANEL
29	3.2 START - FIRST CONNECTION
30	3.3 OPERATING MODES
30	3.4 OFF MODE
31	3.5 AUTO MODE (PRO)
31	3.5.1 TIME PROGRAMMING
32	3.5.2 SETTING THE TIME
32	3.5.3 WEEKLY PROGRAMMING
35	3.5.4 HOW DO I CONFIGURE PRE-SET TEMPERATURES?
37	3.6 MANUAL MODE
38	3.7 LOCKING THE KEYPAD
38	3.8 BOOST FUNCTION - 2 HOUR FUNCTION
39	3.9 “OPEN WINDOWS” SAVE FUNCTION
39	3.10 INTELLIGENT ITCS FUNCTION
40	3.11 ADVANCED FUNCTIONS
41	3.12 DISCONNECTION FROM THE ELECTRICITY / POWER CUT
42	3.13 HAVERLAND APP
43	4. MAINTENANCE

44	1. AVERTISSEMENTS GÉNÉRAUX
46	2. INSTALLATION
49	3. FONCTIONNEMENT
49	3.1 PANNEAU DE COMMANDE
49	3.2 DÉMARRAGE - PREMIÈRE CONNEXION
50	3.3 MODES DE FONCTIONNEMENT
50	3.4 MODE OFF
51	3.5 MODE AUTO (PRO)
51	3.5.1 PROGRAMMATION HORAIRE
52	3.5.2 RÉGLAGE DE L'HEURE
52	3.5.3 PROGRAMMATION HEBDOMADAIRE
55	3.5.4 COMMENT CONFIGURER LES TEMPERATURES DE CONSIGNE?
57	3.6 MODE MANUEL
58	3.7 VERROUILLAGE DU CLAVIER
58	3.8 FONCTION "BOOST" - FONCTION 2 HEURES
59	3.9 FONCTION ÉCONOMIE "FENÊTRES OUVERTES"
59	3.10 FONCTION INTELLIGENTE ITCS
60	3.11 FONCTIONS AVANÇÉES
61	3.12 DÉCONNEXION DU RÉSEAU ÉLECTRIQUE / COUPURE D'ÉLECTRICITÉ
62	3.13 HAVERLAND APP
63	4. ENTRETIEN

64	1. ADVERTÊNCIAS GERAIS
66	2. INSTALAÇÃO
69	3. FUNCIONAMENTO
69	3.1 PAINEL DE CONTROLO
69	3.2 INÍCIO - PRIMEIRA LIGAÇÃO
70	3.3 MODOS DE FUNCIONAMENTO
70	3.4 MODO OFF
71	3.5 MODO AUTO (PRO)
71	3.5.1 PROGRAMAÇÃO HORÁRIA
72	3.5.2 CONFIGURAÇÃO
72	3.5.3 PROGRAMAÇÃO SEMANAL
75	3.5.4 COMO CONFIGURAR AS DEFINIÇÕES DAS TEMPERATURAS?
77	3.6 MODO MANUAL
78	3.7 BLOQUEIO DO TECLADO
78	3.8 FUNÇÃO "BOOST" - FUNÇÃO 2 HORAS
79	3.9 FUNÇÃO ECONOMIA "JANELAS ABERTAS"
79	3.10 FUNÇÃO INTELLIGENTE ITCS
80	3.11 FUNÇÕES AVANÇADAS
81	3.12 DESLIGAR DA REDE ELÉTRICA / CORTE ABASTECIMENTO
82	3.13 HAVERLAND APP
83	4. MANUTENÇÃO

- **Por favor, lea estas instrucciones detenidamente.**
- Para desconectar el emisor de la red eléctrica saque la clavija de alimentación del enchufe. **Nunca tire del cable.**
- No dejar el cable de conexión en contacto con el aparato mientras esté encendido.
- **La garantía del aparato no cubrirá cualquier daño causado por la no lectura de estas instrucciones.**



PELIGRO: NO CUBRIR EL APARATO. NO LO USE PARA SECAR ROPA. Si se cubre, existe el riesgo de producirse un sobrecalentamiento.



• **PELIGRO: Si el cable de alimentación está dañado, debe ser sustituido por el fabricante, por su Servicio Postventa o por personal cualificado similar.**



• **PELIGRO: Si el aparato se va a instalar en un cuarto de baño, debe ser instalado de tal manera que no pueda ser tocado por cualquier persona que se encuentre en la bañera o ducha.**



• **La instalación debe ser efectuada teniendo en cuenta estas instrucciones y acorde a la legislación eléctrica vigente.**

• El aparato no debe estar situado debajo o delante de una toma de corriente.

• La instalación debe ser efectuada según la legislación eléctrica vigente.

• Este aparato debe ser conectado a tierra.

• El emisor debe ser instalado de tal manera que la clavija de alimentación sea siempre accesible.

• **Este emisor térmico es un aparato para fijarlo a la pared. Este emisor no se debe encastrar. Respetar siempre las distancias de seguridad.**

• **Para evitar que los niños puedan variar la programación del emisor, dispone de un bloqueo.**

• Durante su funcionamiento, debe tenerse la precaución de

mantener el aparato alejado de materiales combustibles tales como cortinas, moquetas, muebles, etc.

- Este aparato no está pensado para ser usado por personas (incluidos niños) con capacidades físicas reducidas, sensoriales o mentales, con poca experiencia o conocimiento, al menos que estén bajo supervisión de una persona responsable de su seguridad con las instrucciones de uso del aparato. Los niños deben ser supervisados para asegurar que no juegan con el aparato.

- Los niños menores de 3 años deben mantenerse fuera del alcance del aparato a menos que sean continuamente supervisados. Los niños desde 3 años y menores de 8 años deben sólo encender/apagar el aparato siempre que éste haya sido colocado o instalado en su posición de funcionamiento normal prevista y que sean supervisados o hayan recibido instrucciones relativas al uso del aparato de una forma segura y entiendan los riesgos que el aparato tiene.

- Los niños desde 3 años y menores de 8 años no deben enchufar, regular y limpiar el aparato o realizar operaciones de mantenimiento.

- Este aparato puede ser usado por niños mayores de 8 años y por personas con discapacidades físicas, sensoriales o mentales, o sin experiencia o conocimientos, siempre y cuando hayan sido debidamente formados y sean supervisados por alguien que entienda los riesgos.

- La limpieza y el mantenimiento a realizar por el usuario no se deben hacer por niños. Los niños no deben jugar con el aparato.



- **PRECAUCIÓN: Algunas partes de este producto pueden ponerse muy calientes y causar quemaduras.** Debe ponerse atención particular cuando los niños y las personas vulnerables estén presentes.

- No tocar las partes externas del emisor cuando esté en funcionamiento.

- Antes del primer arranque o antes del comienzo de la campaña de invierno o cuando el emisor no se ha usado durante muchos días, el aparato debe ser limpiado (siga los pasos del punto “mantenimiento” de este manual.

- Es normal que en las primeras puestas en marcha, el aparato produzca olores. Ponga en marcha el aparato en un lugar ventilado durante 2 ó 3 horas.



- **PRECAUCIÓN:** Para evitar riesgos de asfixia, no dejar las bolsas y demás accesorios al alcance de bebés y niños.
- Este emisor **NO puede funcionar** con centralitas externas programables o cualquier otro dispositivo de control exterior.
- El efecto de la convección, junto a otros factores ambientales, puede causar **decoloración en las superficies metálicas y en los plásticos.**
- Los contrastes de temperatura pueden generar “chasquidos” o ruidos en el aparato. Esto no es un fallo del emisor, sino que se debe a la dilatación/contracción del aluminio.
- Cuando se desechen los emisores, deben tenerse en cuenta los requisitos establecidos por la legislación para el tratamiento y reciclaje de los residuos.



IMPORTANTE

- Es indispensable que el emisor **SE FIJE FIRMEMENTE A UNA PARED ESTABLE Y NIVELADA.**
- Comprobar que exista un enchufe cerca de donde lo vaya a situar.
- Saque del interior de la caja de embalaje la plantilla donde se indica la posición de los taladros para colocar el aparato a la pared.
- Para evitar problemas es necesaria una distancia mínima de 15 cm entre el emisor y cualquier material.

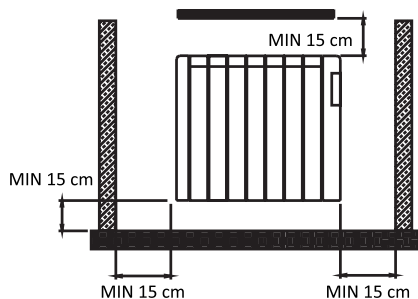

1

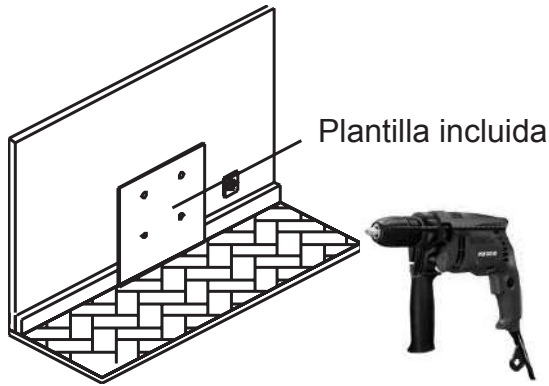

2

Atornille hasta tocar la patilla inferior (M. 6 x 40 mm)

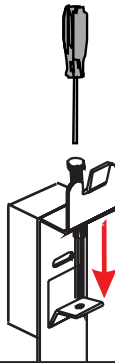

3

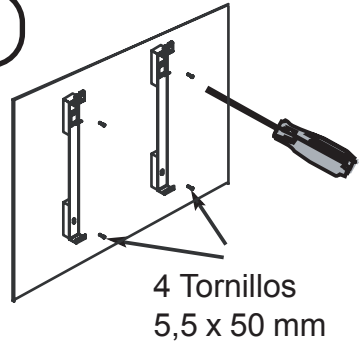

4

Apoye el emisor



5

1. Colocar
2. Caer
3. Apoyar

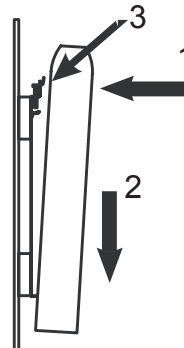

6

**IMPORTANTE:**

Atornille completamente para fijar el emisor

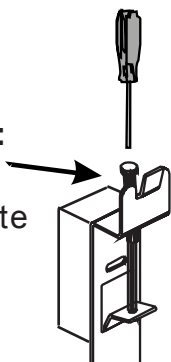

7

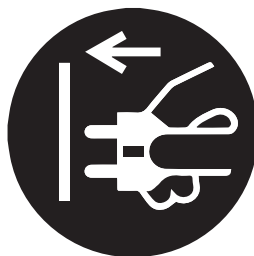

8

Pulsar el interruptor situado en el lateral derecho

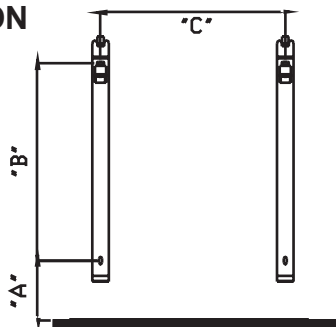
**INFORMACIÓN**

(W)	"A" (mm)	"B" (mm)	"C" (mm)
600	420	246	159
900	420	246	319
1200	420	246	478
1500	420	246	638
1800	420	246	638

3.1 PANEL DE CONTROL

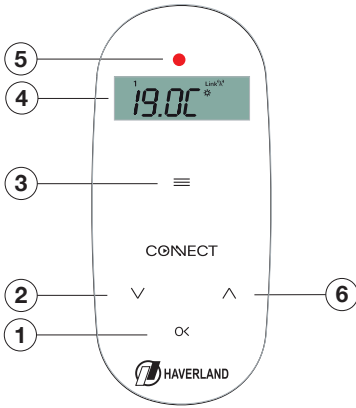

1. Tecla Cambio modo / OK
2. Tecla Disminuir
3. Tecla Configurar / Programar
4. Pantalla
5. Led indicador "en funcionamiento"
6. Tecla aumentar



Iconos Pantalla

1 2 3 4 5 6 Día semana

00:00 Temp./Hora

Link (A) Radiador asociado

☀ ☾ * Temperaturas

🕒 Función ITCS

🔊 Función ventanas abiertas

AUTO Auto

👤 Manual

OFF Stand-by

FP Fil Pilote

AWAY GPS

3.2 INICIO - PRIMERA CONEXIÓN

En el momento que se conecta el emisor a la red eléctrica y pulsa el interruptor, situado en el lateral derecho:

1. Si es la primera vez, aparece en la pantalla "Pr:Hd".
2. Pulsar tecla **OK**. A continuación, se mostrará el reloj y en apagado "OFF".

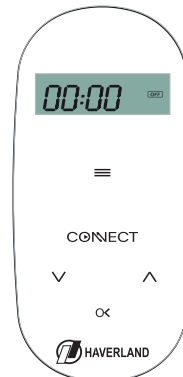
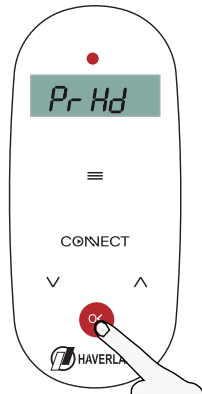

3.3 MODO DE FUNCIONAMIENTO

El aparato tiene 3 modos de funcionamiento: OFF, AUTO (PRO) o MANUAL.

Pulsando sucesivamente la tecla , el emisor cambia de modo "OFF" a "modo AUTO" (PRO) y a modo "MANUAL".

Pulsar sucesivamente
la tecla  para
cambiar de modo de
funcionamiento



OFF

**Modo
OFF**

AUTO

**Modo
Auto**

**Modo
Manual**

El color de fondo de la pantalla cambiará cuando la temperatura de consigna se modifique o varíe, indicando al usuario el rango de temperatura seleccionado y se mostrará:

- **Rojo** si la temperatura es mayor de 24°C
- **Amarillo** si es mayor de 19°C hasta 24°C
- **Verde** si es igual o menor a 19°C

3.4 MODO OFF

Pulse la tecla  hasta que aparezca **OFF** en la pantalla. El aparato permanece SIEMPRE apagado.



3.5 MODO AUTO (PRO)

Pulse la tecla  hasta que aparezca *Pro* y **AUTO** en la pantalla.

La temperatura de consigna varía automáticamente según programación personalizable basada en 3 temperaturas de consigna (Confort, Eco, Anti-hielo) o el estado OFF.



Dentro del modo Auto se puede subir o bajar la temperatura temporalmente. Esta modificación temporal se mantiene hasta el siguiente cambio en la programación o por cambio al siguiente día.





El rango de temperatura en modo auto, va de 5 °C hasta 30°C.

3.5.1 PROGRAMACIÓN HORARIA:

Para un uso eficiente de su radiador recomendamos usar el modo AUTO (PRO). Programe su aparato con las horas concretas que necesite de calefacción en la estancia.

El radiador permite asignar una de las 3 temperaturas posibles a cada una de las horas o bien ponerlo en OFF. La programación puede ser distinta cada día.

- Temperatura confort : para las horas en que se encuentre en la vivienda.
- Temperatura economía : para las horas nocturnas o periodos cortos de ausencia de la vivienda.
- Temperatura anti-hielo : para periodos de ausencia prolongados.
- OFF **OFF**: Cuando quiera programar periodos de desconexión del equipo.

3.5.2 PUESTA EN HORA:

ACCIÓN

1 Pulse la tecla  durante **3 segundos**. El día parpadea.

2 Pulse las teclas   para ajustar. Pulse  para validar.

1	2	3	4	5	6	7
LUNES	MARTES	MIÉRCOLES	JUEVES	VIERNES	SÁBADO	DOMINGO

3 Luego, de la misma manera, ajuste la hora y los minutos.

Pulse  salir del menú "Puesta en hora".

PANTALLA



3.5.3 PROGRAMACIÓN SEMANAL:

Dependiendo de sus necesidades, el radiador dispone de 4 opciones para realizar una programación semanal.

OPCIÓN 1: TODOS LOS DÍAS CON DIFERENTE PROGRAMACIÓN.

Configurar cada día de la semana con una programación distinta.

**OPCIÓN 2: MISMA PROGRAMACIÓN TODOS LOS DÍAS DE LA SEMANA.**

La programación que se configure el lunes, se repite el resto de días de la semana.

**OPCIÓN 3: PROGRAMACIÓN DÍAS LABORALES Y FIN DE SEMANA.**

Primero se programa con la misma programación de lunes a viernes, y después el fin de semana con una programación distinta.

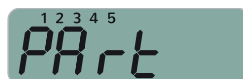

3. FUNCIONAMIENTO

ES

OPCIÓN 4: PROGRAMACIÓN FIN DE SEMANA. IDEALES PARA SEGUNDAS VIVIENDAS.

De forma automática se asigna OFF de lunes a jueves, y se configura la misma programación para el viernes, sábado y domingo.

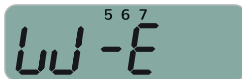

ACCIÓN

PANTALLA

- 1 Pulse la tecla durante **3 segundos**. El día parpadea.



- 2 Pulse salir del menú "Puesta en hora" y entrar en el menú de selección "Opción de programación".



- 3 Pulse las teclas para elegir la opción de programación deseada ONE, ALL, PArt o WE.

Pulse para confirmar.

La hora 0:00 y el día 1 está seleccionado. Si el programa ha sido anteriormente configurado, se visualizará la última alteración.



La programación por defecto de fabrica es todos los días y horas en economía.

- 4 Pulse sucesivamente la tecla para elegir el modo que se desee para dicha hora del día 1:

Anti-hielo , economía , confort o OFF .



Antihielo

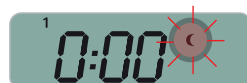

Economía



Confort



OFF



ES

ACCIÓN

PANTALLA

- 5 Pulse las teclas   para avanzar o retroceder a la hora siguiente.



Una pulsación prolongada de las teclas  o , avanza o retrocede rápidamente las horas sin modificar la programación.



- 6 Pulse sucesivamente la tecla  para elegir el modo que se desee para dicha hora 1:00 del día 1:

Anti-hielo , economía , confort  o OFF .

Repita el proceso para cada hora y para día a configurar, según la opción de programación elegida.



Manteniendo pulsada la tecla  durante 3 segundos podrá copiar el modo elegido, confort, economía, antihielo o standby, de la hora anterior.



Pulsando la tecla  podrá avanzar de día y salir del menú programación.



El led situado encima de la pantalla se encenderá cuando el radiador esté calentando.



En modo AUTO (PRO), se mostrará en la pantalla alternativamente la palabra PRO y la temperatura de consigna elegida, según esté en confort, economía o antihielo.













3.5.4 ¿CÓMO CAMBIAR LAS TEMPERATURAS DE CONSIGNA?

En el modo AUTO (PRO) las temperaturas de consigna (confort, economía y antihielo) irán cambiando automáticamente según la programación establecida por el usuario, que asignará a cada hora una de las cuatro posibilidades:

Antihielo ❄️, economía 🌙, confort ☀️ o OFF [OFF].

Para establecer los valores de las tres temperaturas:

ACCIÓN	PANTALLA
<p>1 Pulse la tecla . Aparecerán los siguientes símbolos en la pantalla:</p> <p>Por defecto aparece ya seleccionada (parpadeando) la opción definir temperaturas.</p> <p>Pulse la tecla .</p>	
<p>2 Una vez en la pantalla de selección de temperaturas aparece el icono de confort ☀️ junto con el valor asignado actualmente.</p> <p>Pulse las teclas   para elegir la temperatura de confort deseada.</p> <p>Pulse la tecla  para pasar a elegir la temperatura de economía.</p>	
<p>Pulse las teclas   para elegir la temperatura de economía deseada.</p> <p>Pulse la tecla  para pasar a elegir la temperatura de antihielo.</p>	
<p>Pulse las teclas   para elegir la temperatura de antihielo deseado.</p> <p> La temperatura de antihielo puede ser ajustada entre 5 y 7°C.</p> <p>Pulse la tecla  para confirmar.</p> <p>Para salir del menú, pulse la tecla .</p>	



El color de fondo de la pantalla cambiará cuando la temperatura de consigna se modifique o varíe, indicando al usuario el rango de temperatura seleccionado y se mostrará:







- **Rojo** si la temperatura seleccionada es mayor de 24 °C
- **Amarillo** si es mayor de 19 °C hasta 24 °C
- **Verde** si es igual o menor a 19 °C



El ajuste de las temperaturas de confort y economía se podrá realizar entre 7 °C hasta 30 °C, teniendo en cuenta que la temperatura de economía **SIEMPRE SERÁ 2 °C INFERIOR** a la temperatura de confort seleccionada y la temperatura de economía **SIEMPRE SERÁ 2 °C SUPERIOR** a la temperatura de antihielo seleccionada.

3.6 MODO MANUAL

En modo manual, el radiador funciona como un termostato de ambiente.

ACCIÓN	PANTALLA
<p>1 Elija el modo manual pulsando la tecla  hasta que aparezca el símbolo “mano”  en la pantalla.</p> <p>La temperatura que se muestra en pantalla, es la temperatura seleccionada en modo manual previamente.</p> <p>i La temperatura prefijada de fábrica, en modo manual, es de 19 °C.</p>	
<p>2 Pulse las teclas   para elegir la temperatura deseada, por ejemplo, 21 °C.</p>	





El led situado encima de la pantalla se encenderá cuando el radiador esté calentando.



La temperatura seleccionada en modo manual no está relacionada con la temperatura de confort. Son temperaturas independientes y por ello, debe ser configuradas por separado.

3.7 BLOQUEO DE TECLADO

Presione simultáneamente las teclas  y  hasta que aparezca en la pantalla la palabra **LoCh**.

Debe realizar la misma operación para desbloquear el teclado.



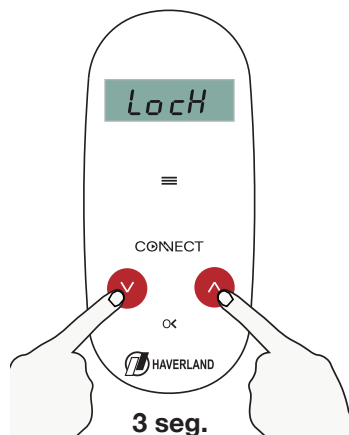

Aparece “**LoCh**” en pantalla, si el teclado está bloqueado.



3.8 FUNCIÓN “BOOST” - FUNCIÓN 2 HORAS

Esta función pone el aparato en funcionamiento a máxima potencia durante dos horas, independientemente del modo de funcionamiento que esté seleccionado. Esta función tiene prioridad sobre cualquier otra.

Para activar esta función pulse simultáneamente las teclas  y  hasta que aparezca “**bSt**” en pantalla.

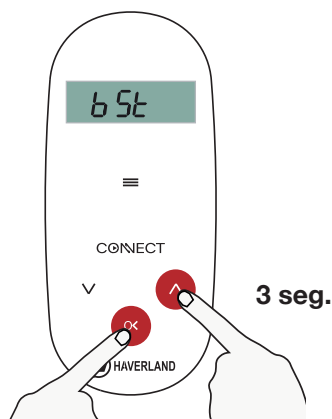

Al activarse esta función, aparece “**bSt**” en pantalla.

Puede desactivar la función “Boost” antes de finalizar las 2 horas, pulsando cualquier tecla.

3.9 FUNCIÓN AHORRO “VENTANAS ABIERTAS”

Esta función se activa cuando se produce un descenso brusco de la temperatura en la habitación.



Al activarse esta función, aparece el símbolo  en la pantalla. El aparato se desconectará evitando un consumo de energía innecesario.



Al cerrar la ventana, el radiador detectará una subida de temperatura y se desactivará esta función.

El aparato se encenderá de nuevo volviendo al estado anterior a la desconexión.



Esta función inteligente está activada de serie. Puede ser desactivada por el usuario; consulte el punto 3.11 “Funciones avanzadas”.

3.10 FUNCIÓN INTELIGENTE ITCS

El radiador incorpora un **innovador sistema de control inteligente de temperatura ITCS**.

Este sistema activa la puesta en marcha del aparato con **antelación a la hora programada** (2 horas máximo), para asegurar que se consigue la temperatura deseada a la hora indicada y siguiendo el programa semanal establecido.



Al activarse esta función, aparece el símbolo  en la pantalla.

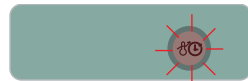

Esta función inteligente está desactivada de serie. Puede ser activada por el usuario; consulte el punto 3.11 “Funciones avanzadas”.

3.11 FUNCIONES AVANZADAS

Este radiador incorpora las siguientes funciones:

Función	Ajuste
C1 Ajuste de °C o °F	Permite cambiar de grados Celsius a grados Fahrenheit.
C2 Ajuste del tipo de control (PID, histéresis, etc.).	Esta función es para usuarios con conocimientos en electrónica. Se ruega no entrar en esta función; podría desconfigurar el aparato
C3 Ajuste medición de temperatura	Permite calibrar y ajustar la temperatura que mide el termostato.
C4 Versión de firmware	Número de versión de firmware del aparato.
C5 Activación / Desactivación función ventanas abiertas	Permite desactivar o activar la función ventanas abiertas. Por defecto, la función está activada.
C6 Activación / Desactivación función ITCS	Permite desactivar o activar la función ITCS. Por defecto, la función está desactivada.
C7 Activación / Desactivación función "hilo piloto" (Fil Pilote)	Permite desactivar o activar la función "hilo piloto" (Fil Pilote). Por defecto, la función está desactivada. Está función solo está disponible en Francia.

ACCIÓN

PANTALLA

- 1 Pulse la tecla .

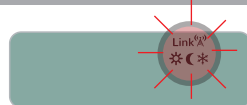







- 2 Pulse de nuevo la tecla  durante **5 segundos**. A continuación, aparece en la pantalla el primer ajuste, C1.



- 3 Pulse las teclas   para seleccionar el ajuste que desea modificar (C1 a C7), por ejemplo C6.

Pulse  para entrar en el ajuste que se desea modificar.



ACCIÓN	PANTALLA
<p>4 Pulse las teclas   para modificar el ajuste seleccionado.</p>	
<p>5 Pulse  para confirmar el ajuste. Automáticamente se sale al menú de configuración avanzada.</p>	
<p>6 Pulse la tecla  para salir.</p>	

3.12 DESCONEXIÓN RED ELÉCTRICA / CORTE SUMINISTRO

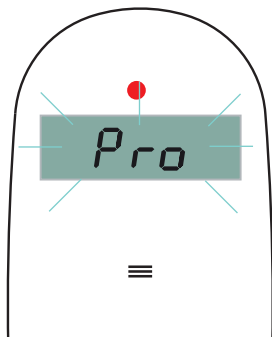

Si el radiador se mantiene desconectado de la red eléctrica (por ejemplo, interruptor del emisor desconectado) o si se produce un corte del suministro eléctrico **superior a 30 minutos**, aparecerá en la pantalla **“Pr:Hd”** y la pantalla parpadeará.

Debe configurar la hora y el día siguiendo el punto 3.5.2 PUESTA EN HORA.

El resto de los parámetros programados se mantienen en memoria.

3.13 HAVERLAND APP

Para controlar todas las funciones de sus radiadores, a través de su smartphone o tablet, descargarse gratis nuestra Haverland app  en la AppleStore o en Google Play.

- 1 Siga el asistente de la app.
- 2 Para añadir el aparato a la app, **pulse la opción “+SERIE CONNECT”**. A continuación, pulse la tecla  en su radiador hasta que la luz de la pantalla parpadee.



- 3 Seleccione su red wifi y escriba su contraseña. Empezará el proceso de configuración con su radiador.



- 4 Una vez terminado todos los pasos, aparecerá en la pantalla de su radiador el indicador Link[®].

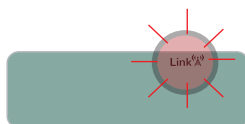

- 5 El aparato queda correctamente enlazado. Repita desde el punto 2 con cada radiador que disponga.

4. MANTENIMIENTO

Su aparato no precisa de ningún tipo de mantenimiento especial.

Solamente limpie el polvo que se pueda acumular con un trapo seco y suave.

Es conveniente al comenzar la temporada de invierno, limpiar el polvo acumulado sobre la superficie del radiador.



NUNCA UTILICE DISOLVENTES NI PRODUCTOS ABRASIVOS.

- **Please read these instructions carefully.**
- To disconnect mains power from the radiator remove the plug from the wall socket, but **never pull on the cable.**
- Do not leave the mains cable in contact with the radiator when it is switched on.
- During operation, the radiator must be kept well away from combustible materials, such as curtains, carpets and furniture etc.
- **The warranty for the radiator does not cover any damage caused by not reading these instructions.**



WARNING: In order to avoid overheating, do not cover the heater.



• **WARNING: If the mains power cable is damaged, it must be replaced by the manufacturer, with their after-sales service or similar qualified persons, in order to prevent any danger.**



• **WARNING: If the heater is to be installed in a bathroom, it must be positioned so that it cannot be touched by anybody in the bath or shower.**



• **The installation should be carried out with consideration to the manufacturer's instructions and in accordance to the relevant National Wiring Regulations BS7671.**

• It is very important that radiator has a good Electric Earth connection.

• The radiator shall be installed so that its mains plug is always accessible.

• The radiator must not be installed below or in front of a mains socket.

• **This radiator cannot be surface-mounted with a wall. Safety distances shall always be respected.**

- **The radiator has a keyboard blockage option to prevent children from changing the programming.**

- This unit is not designed to be handled by persons (including children) with physical, sensorial or mental handicaps, with little experience or knowledge unless they are under the supervision of an adult responsible for their safety with the instructions on its use. Children shall always be supervised to ensure they do not play with the unit.

- Children under three shall be kept well away from the heater unless they are continually supervised.

- Children between three and eight shall only switch the unit off or on providing it is positioned or installed in its final operating location and be supervised or have received instructions on how to use the unit in a safe manner and understand the risks involved.

- Children between three and eight shall not plug in, adjust or clean the heater or carry out any maintenance operations.

- This unit may be used by children older than eight and by persons with physical, sensorial or mental handicaps, with little experience or knowledge, provided they have been duly trained and are supervised by an adult that understands the risks involved.

- Cleaning and maintenance shall be performed by adults not children. Children must not play with the unit.



- **WARNING: Certain parts of this product can become very hot and cause burns.** Special attention shall be paid when children and other vulnerable persons are present.

- Do not touch the external parts of the radiator when it is operating.

- It is quite normal that, with the first switch-on, the unit produces a “new” smell. Allow your heater to operate in a well-ventilated place for two or three hours.

- Before the first switch on for the coming winter or when the heater has not been used for several days, the unit should be cleaned (follow the steps given in the “maintenance section”). This cleaning operation will avoid burning the accumulated dust and other remains.



- This radiator **CAN'T OPERATE** with external programmable controllers or any other exterior control device.
- **CAUTION:** Keep bags and other accessories well out of the reach of children.
- The convection effect, together with other ambient factors, can cause discolouring to metal surfaces and to plastics.
- Temperature differences can cause crackling and other noises in the unit. This does not indicate any failure in the radiator.
- When the radiator is disposed of, the requirements established by current legislation on waste processing and recycling shall be taken into account.



IMPORTANT

- It is important that the radiator **IS FIXED FIRMLY TO A SOLID AND LEVELLED WALL**.
- Make sure that there is a socket near the area where you are going to place it.
- Take out the wall pattern from the box to see the exact positions of the necessary drill holes.
- You must keep a minimum distance of 15 cm between the radiator and any object, wall or combustible material.

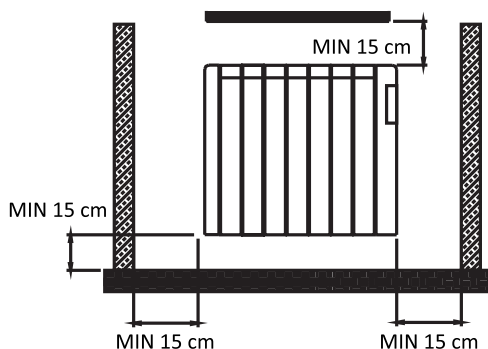

1

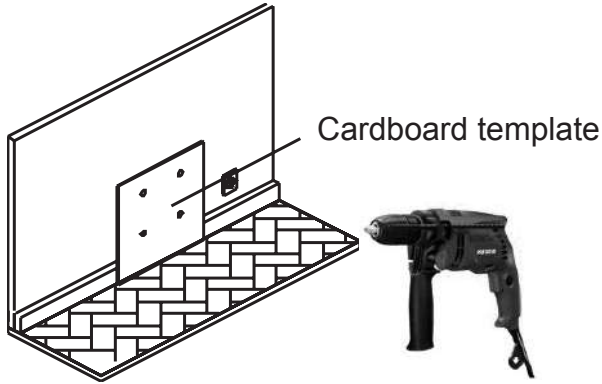

2

Place the screw
but don't
screw it fully.
(M. 6 x 40 mm)

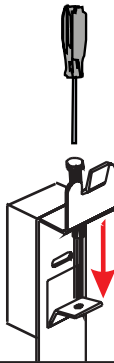

3

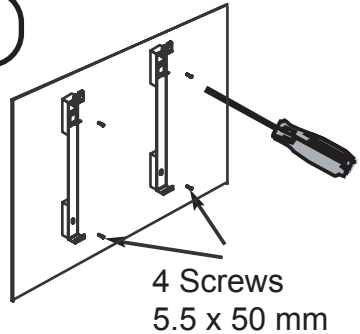

4

Place
the radiator



5

Slide the
radiator up,
Place over top
tang and lower
gently into
position

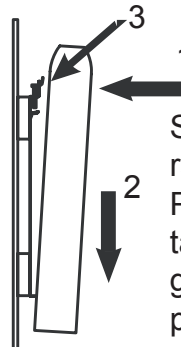

6



IMPORTANT:
Screw down
FULLY to lock
the radiator

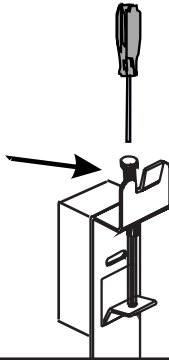

7

Plug in
3 pin 13 amp
plug

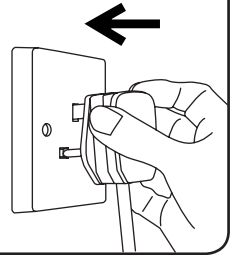

8

Press ON /
OFF switch
located at the
right rear part
of the unit.

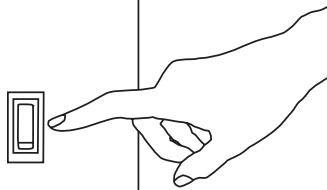

INFORMATION

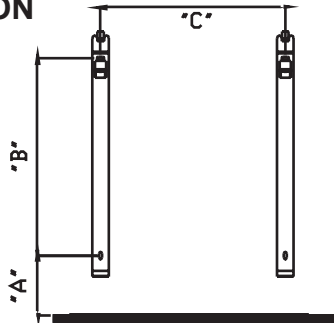

(W)	"A" (mm)	"B" (mm)	"C" (mm)
600	420	246	159
900	420	246	319
1200	420	246	478
1500	420	246	638
1800	420	246	638

3.1 CONTROL PANEL

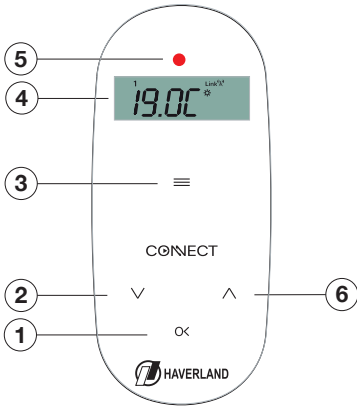

1. Change mode / OK button
2. Decrease button
3. Configure / Programme button
4. Screen
5. "In operation" indicator LED
6. Increase button



Screen Icons

1 2 3 4 5 6 Day of the week

88:88 Temp/Time

Link Associated radiator

Temperatures

ITCS Function

Open windows function

Auto

Manual

Stand-by

Pilot wire

GPS

3.2 START - FIRST CONNECTION

As soon as the radiator is connected to electricity, press the switch located on the right side:

1. if this is the first time you are connecting the radiator, "Pr:Hd" will appear on screen..

2. Press the button. Then, the clock will display and it will switch to "OFF".

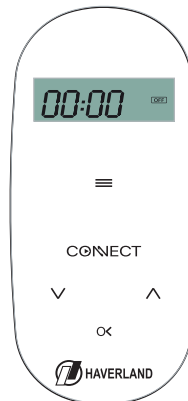
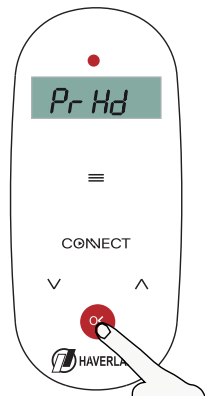

3.3 OPERATING MODES

The device has 3 operating modes: OFF, AUTO (PRO) or MANUAL.

By pressing the  button successively, the transmitter changes from “OFF” mode to “AUTO mode” (PRO) and to “MANUAL” mode.

Successively press the  button to change the operating mode.

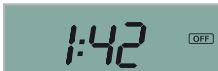

OFF
OFF
Mode



AUTO
Auto
Mode





Manual
Mode



The background colour of the screen will change when the pre-set temperature is modified or changed, indicating the selected temperature range to the user by showing:

- **Red** if the temperature is over 24°C
- **Yellow** if it is higher than 19° and up to 24°C
- **Green** if it is equal to or lower than 19°C

3.4 OFF MODE

Press the  button until **OFF** appears on screen. The device ALWAYS remains switched off.

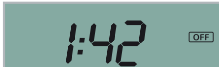

3.5 AUTO MODE (PRO)

Press the  button until *Pro* and **AUTO** appear on screen.

The pre-set temperature will change automatically according to the bespoke programming, based on 3 pre-set temperatures (Comfort, Eco, Anti-freeze) or the OFF mode.



In Auto mode, the temperature can be temporarily raised or lowered. This temporary modification is maintained until the next programming cycle or until midnight.





You can choose a temperature between 5 and 30 °C







3.5.1 TIME PROGRAMMING:

For an efficient use of your radiator, we recommend using the AUTO (PRO) mode. Programme your device with the specific hours you require heating in the room.

The radiator can be assigned one of the 3 possible temperatures for each hour or can be set to OFF. The programming can be different every day.

- Comfort temperature  for the hours you spend at home.
- Economy temperature:  for night hours or short periods of absence from your home.
- Anti-freeze temperature  : for periods of prolonged absence.
- OFF **OFF** : When you want to program periods of disconnection (switch the radiator off).

3.5.2 SETTING THE CLOCK:

ACTION							SCREEN
1 Press the  button for 3 seconds . The day will flash.							
2 Press the   buttons to set. Press  to validate.							
1	2	3	4	5	6	7	
MONDAY	TUESDAY	WEDNESDAY	THURSDAY	FRIDAY	SATURDAY	SUNDAY	
3 Then, set the hour and minutes in the same way. Press  to exit the "Setting the clock" menu.							

3.5.3 WEEKLY PROGRAMMING:

Depending on your needs, the radiator has 4 options for setting a weekly programme.

OPTION 1: EVERY DAY WITH A DIFFERENT PROGRAMME.

Set each day of the week to have a different programme.



OPTION 2: SAME PROGRAMME FOR EACH DAY OF THE WEEK.

The programme set for Monday is repeated on each other day of the week.



OPTION 3: WEEKDAYS AND WEEKENDS PROGRAMME.



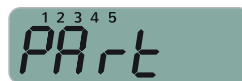





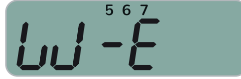









The same programme is firstly scheduled for Monday through to Friday, and then the weekend has a different programme.



OPTION 4: WEEKEND PROGRAMMING. IDEAL FOR SECOND HOMES.

The programme is automatically set to OFF from Monday to Thursday, and then the same programme is set for Friday, Saturday and Sunday





ACTION	SCREEN
<p>1 Press the  button for 3 seconds. The day will flash.</p>	
<p>2 Press  to exit the "Setting the clock" menu and enter the "Programming option" selection menu.</p>	
<p>3 Press the   keys to choose the desired programming option: ONE, ALL, PART or WE. Press  to confirm.</p>	
<p>The time 00:00 and day 1 is selected. If the programme has been previously configured, the last change will be displayed.</p> <p> The default factory program is all days and hours in economy.</p>	
<p>4 Successively press the  key to choose the desired mode for this hour of day 1: Anti-freeze , economy , comfort  or OFF .</p>	 <p style="text-align: center;">Anti-freeze</p>  <p style="text-align: center;">Economy</p>  <p style="text-align: center;">Comfort</p>  <p style="text-align: center;">OFF</p>

ACTION

SCREEN

- 5 Press the   keys to progress or go back to the next hour.



By holding the  or  buttons, the hours change quickly without modifying the programming.



- 6 Successively press the  key to choose the desired mode for hour 1:00 of day 1:

Anti-freeze , economy , comfort  or OFF .

Repeat the process for each hour and day to configure according to the chosen programming option.



By holding the  button for 3 seconds, you can copy the chosen mode (comfort, economy, anti-freeze or standby) from the previous hour.



By pressing the  button, you can go forward a day and exit the programming menu..



The LED located above the screen will switch on when the radiator is heating.



In AUTO mode (PRO), the screen will alternatively display the word PRO and the chosen pre-set temperature, according to whether it is in comfort, economy or anti-freeze.













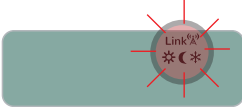





3.5.4 HOW DO I CHANGE THE PRE-SET TEMPERATURES?

In AUTO mode (PRO), the pre-set temperatures (comfort, economy and anti-freeze) will automatically change according to the programming established by the user, who will assign of the four possibilities to each hour:

Anti-freeze ❄️, economy 🌙, comfort ☀️ or OFF [OFF].

To establish the values of the three temperatures:

ACTION	SCREEN
<p>1 Press the  button. The following symbols will appear on screen:</p> <p>By default, the option to define temperatures is already selected (flashing).</p> <p>Press the  button.</p>	
<p>2 Once in the temperature selection screen, the comfort icon ☀️ will appear next to the currently pre-set value.</p> <p>Press the   buttons to choose the desired comfort temperature.</p> <p>Press the button  to choose the economy temperature</p>	
<p>Press the   buttons to choose the desired economy temperature.</p> <p>Press the  button to choose the anti-freeze temperature.</p>	
<p>Press the   buttons to choose the desired anti-freeze temperature.</p> <p> The anti-freeze temperature can be adjusted between 5 and 7°C.</p> <p>Press the  button to confirm.</p> <p>To exit the menu, press the  button.</p>	



The background colour of the screen will change when the pre-set temperature is modified or changed, indicating the selected temperature range to the user by showing:







- **Red** if the selected temperature is over 24°C
- **Yellow** if it is higher than 19° and up to 24°C
- **Green** if it is equal to or lower than 19°C



The adjustment of the comfort and economy temperatures can be set between 7°C and 30°C, taking into account that the economy temperature **WILL ALWAYS BE 2°C LOWER** than the selected comfort temperature, and the economy temperature **WILL ALWAYS BE 2°C HIGHER** than the selected anti-freeze temperature.

3.6 MANUAL MODE

In manual mode, the radiator works like a room thermostat.

ACTION	SCREEN
<p>1 Choose the manual mode by pressing the  key until the “hand” symbol  appears on screen.</p> <p>The temperature shown on screen is the temperature that was previously selected in manual mode.</p> <p>i The pre-set factory temperature, in manual mode, is 19°C.</p>	
<p>2 Press the   buttons to choose the desired temperature, for example, 21°C.</p>	



The LED located above the screen will switch on when the radiator is heating.



The temperature selected in manual mode is not related to the comfort temperature. They are independent temperatures and, therefore, must be configured separately.

3.7 LOCKING THE KEYPAD

Simultaneously press the  and  buttons until the word **LoCh** appears on screen.

The same operation must be performed to unlock the keypad.



“LoCh” will appear on screen if the keypad is locked.

3 seconds

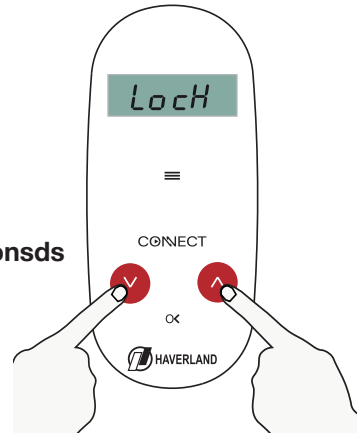

3.8 BOOST FUNCTION - 2 HOUR FUNCTION

This function puts the device into operation at full power for two hours, regardless of the operation mode that is selected. This function has priority over any other.

To activate this function, simultaneously press  and  buttons until the “bSt” appears on screen.

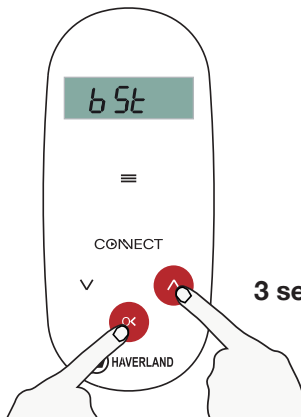

3 seconds



By activating this function, “bSt” appears on screen.

You can deactivate the Boost function before the 2 hours have elapsed by pressing any button.

3.9 “OPEN WINDOWS” SAVE FUNCTION

This function activates when there is a sudden drop in the room’s temperature.



By activating this function, the symbol  appears on screen. The device will disconnect, preventing an unnecessary consumption of energy.



When closing the window, the radiator will detect a rise in temperature and this function will deactivate.

The device will switch on again, returning to the status it was in before it disconnected.



This intelligent function is activated as standard. This can be deactivated by the user; consult point 3.11 “Advanced functions”.

3.10 INTELLIGENT ITCS FUNCTION

The radiator incorporates an **innovative intelligent temperature control system (ITCS)**.

This system activates the start-up of the device **before the programmed time** (2 hours maximum), to ensure that the desired temperature is achieved at the indicated time and by following the established weekly programme.



By activating this function, the symbol  appears on screen.

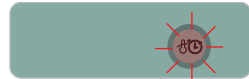

This intelligent function is deactivated as standard. This can be activated by the user; consult point 3.11 “Advanced functions”.

3.11 ADVANCED FUNCTIONS

This radiator incorporates the following functions:

Function	Setting
C1 Adjustment of °C or °F	This allows you to change from degrees Celsius to degrees Fahrenheit.
C2 Adjustment of the control type (PID, hysteresis, etc.).	This function is for users with knowledge in electronics. Please do not enter this function, it could reconfigure the device.
C3 Temperature measurement adjustment	This allows you to calibrate and adjust the temperature measured by the thermostat.
C4 Firmware version.	Version number of the device's firmware.
C5 Open windows activation/deactivation function	This allows you to activate or deactivate the open windows function. The function is activated by default.
C6 ITCS activation/deactivation function	This allows you to activate or deactivate the ITCS function. The function is deactivated by default.
C7 "Pilot wire" activation/deactivation function	This allows you to activate or deactivate the "Pilot wire" function. The function is deactivated by default. This function is only available in France.

ACTION

SCREEN

1 Press the  button.









2 Press the  button again for **5 seconds**. Then, the first setting, C1, appears on screen.



3 Press the   buttons to choose the setting you wish to modify (C1 to C7), for example, C6.

Press  to enter the setting you wish to modify.



ACTION	SCREEN
<p>4 Press the   buttons to modify the chosen setting.</p>	
<p>5 Press  to confirm the setting. The device will automatically exit the advanced settings menu.</p>	
<p>6 Press the  button to exit.</p>	

3.12 DISCONNECTION FROM THE ELECTRICITY / POWER CUT

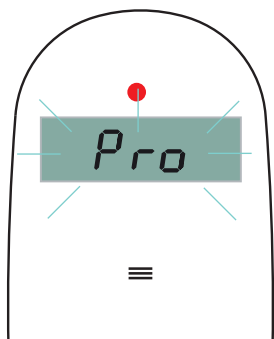

If the radiator remains disconnected from the electricity (for example, the radiator switch is disconnected) or if a power cut occurs that lasts **longer than 30 minutes**, **“Pr:Hd”** will appear on screen and the screen will flash.

You must set the time and day by following point 3.5.2 SETTING THE CLOCK.

All other programmed parameters will remain in the memory

3.13 HAVERLAND APP

To control all functions of your radiators, you will need our free Haverland app.

You can download our Haverland app  for free on the Apple Store or on Google Play.

1 Follow the instructions on the app.

2 To link the device in the app, press **“+CONNECT SERIES”** button. Then, press the button until the radiator’s screen flashes. 



3) Select your wifi network and enter your password. Please wait until the App finishes the configuration of your radiator.



- 4 Once all the steps are finished, the Link⁶ indicator will appear on the screen of your radiator.

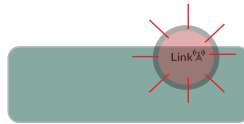

- 5 The device is correctly linked. Please repeat the process from point 2 for each radiator.

4. MAINTENANCE

Your device does not require any type of special maintenance.

You need only clean any dust that may accumulate with a dry and soft cloth.

We advise that you clean any accumulated dust from the radiator surface at the beginning of the winter season.



NEVER USE SOLVENTS OR ABRASIVE PRODUCTS.

- **Veillez lire les instructions explicatives.**
- Pour déconnecter le radiateur du réseau électrique, retirez le câble d'alimentation de la prise de courant. **Ne jamais tirer du câble électrique.**
- Ne pas laisser le câble de connexion en contact avec l'appareil pendant qu'il est allumé.
- **La garantie de l'appareil ne tiendra pas en compte des dommages causés par la non lecture de ces instructions.**



DANGER: NE PAS COUVRIR L'APPAREIL. NE PAS L'UTILISER POUR SÉCHER LE LINGE.
Le couvrir occasionnerait un danger, car il pourrait se produire une surchauffe.



• **DANGER:** Si le câble d'alimentation s'abîme il faudra le faire remplacer par un Service Technique Autorisé afin d'éviter un risque quelconque.



• **DANGER:** Si l'appareil va être installé dans une salle de bain, il doit être placé de telle sorte que l'appareil ne puisse pas être touché par n'importe quelle personne qui se trouve dans la baignoire ou la douche.



• **L'installation doit être effectuée selon les instructions du fabricant et conformément à la législation électrique en vigueur.**

• L'appareil ne doit pas être placé en dessous ou devant une prise de courant.

• Pendant son fonctionnement, il faudra prendre la précaution de maintenir éloigné l'appareil de matériaux combustibles tels que rideaux, moquettes, meubles, etc.

• L'installation doit être effectuée selon la législation électrique en vigueur.

• Cet appareil doit être connecté à une prise de terre.

• Le radiateur doit être installé de telle manière que le câble électrique d'alimentation soit parfaitement accessible.

• **Cet radiateur est un appareil qui doit être fixé au mur. Ce radiateur ne doit pas être encastré. Respectez toujours les distances de**

sécurité.



• **Pour éviter que les enfants ne puissent modifier la programmation de l'émetteur, ce-lui-ci dispose d'un blocage.**

• Cet appareil n'est pas conçu pour être utilisé par des personnes (y compris les enfants) ayant des capacités physiques, sensorielles ou mentales réduites, avec peu d'expérience ou de connaissance, à moins qu'elles ne soient sous la supervision d'une personne responsable de leur sécurité, avec les instructions d'usage de l'appareil. Les enfants doivent être supervisés pour s'assurer qu'ils ne jouent pas avec l'appareil.

• Les enfants âgés de moins de 3 ans doivent se maintenir hors de portée de l'appareil, à moins qu'ils ne soient continuellement supervisés.

• Les enfants de 3 ans à 8 ans peuvent allumer / éteindre l'appareil, seulement si celui-ci a été placé ou installé dans sa position de fonctionnement normal prévue, et s'ils sont supervisés ou qu'ils ont reçu des instructions relatives à l'usage de l'appareil de façon sûre, et aient les risques que renferme l'appareil.

• Les enfants de 3 ans à 8 ans ne doivent pas brancher, ni régler, ni nettoyer l'appareil ni réaliser des opérations de maintenance.

• Cet appareil peut être utilisé par les enfants à partir de 8 ans et les personnes avec capacités physiques, sensorielles ou mentales réduites avec peu d'expérience et de connaissance, si elles ont reçu la supervision ou la formation convenable en ce qui concerne l'utilisation de l'appareil de façon sûre et qu'elles comprennent les dangers qu'il implique. Le nettoyage et la maintenance à réaliser par l'utilisateur ne doivent pas être effectués par des enfants. Les enfants ne doivent pas jouer avec l'appareil.



• **PRÉCAUTION : Certaines parties de ce produit peuvent devenir très chaudes et provoquer des brûlures.**

• Avant chaque saison hivernale, ou si l'appareil a été débranché pendant plusieurs jours, nettoyez l'appareil avant de le connecter (suivez les étapes "section Maintenance"). Avec ledit nettoyage, vous éviterez de faire brûler la poussière accumulée et autres restes.

- Il est normal que, lors du premier démarrage, l'appareil puisse dégager une odeur. Faites fonctionner votre émetteur dans un lieu ventilé pendant 2 ou 3 heures.
- Il faudra y accorder une attention particulière lorsque des enfants et/ou des personnes vulnérables seront présents.
- Évitez de toucher les parties externes de l'émetteur pendant son fonctionnement.
- Le radiateur **NE peut pas fonctionner** avec des centrales externes de programmation ou tout autre dispositif de contrôle extérieur.
- **PRÉCAUTION** : Pour éviter tout danger d'asphyxie, gardez ce sac en plastique hors de portée des bébés et des enfants.
- L'effet de la convection, conjointement avec d'autres facteurs environnementaux, peut provoquer une décoloration dans les surfaces métalliques et plastiques.
- Les contrastes de température peuvent générer "des craquements" ou des bruits dans l'appareil. Ceci n'est pas une défaillance du radiateur.
- Au moment de jeter les radiateurs, il faudra tenir compte des exigences requises par la législation pour le traitement et recyclage des résidus.



IMPORTANT

- Il est indispensable **FIXER FERMEMENT le radiateur A UN MUR SOLIDE ET NIVELÉ.**
- Vérifier qu'il y a une prise de courant proche de l'endroit où vous souhaitez le situer.
- Prenez de l'intérieur de la boîte d'emballage le patron qui indique la position exacte.
- Pour éviter des problèmes, la distance minimum de 15 cm est nécessaire entre le radiateur et tout autres matériaux.

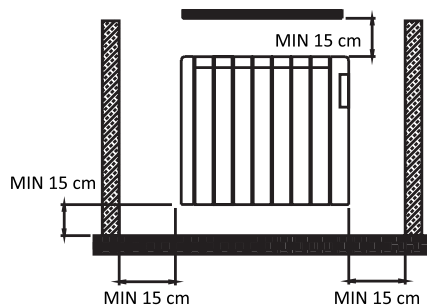

1

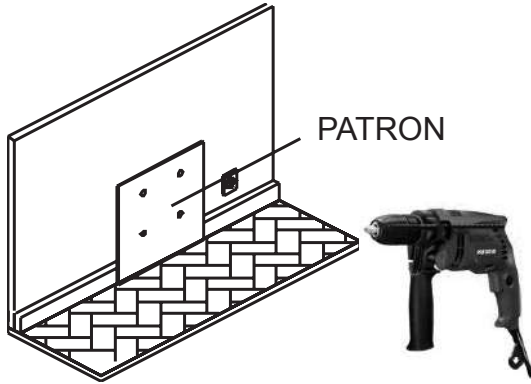

2

Visser
complètement
sans appuyer
(M. 6 x 40 mm)

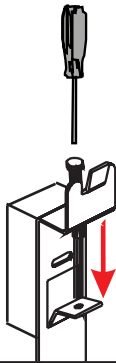

3

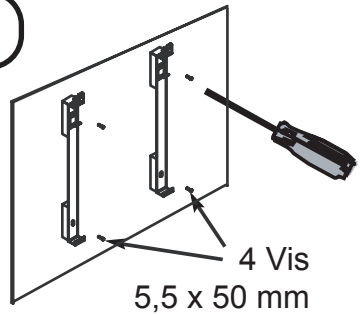

4

Soutenir
le radiateur

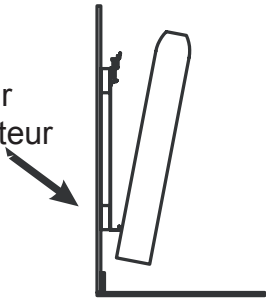

5

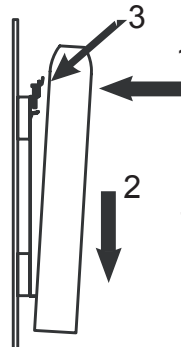

1. Déplacer
2. Laisser
tomber
doucement
3. Soutenir

6

**IMPORTANT:**

Visser
complètement pour
ajuster le
radiateur

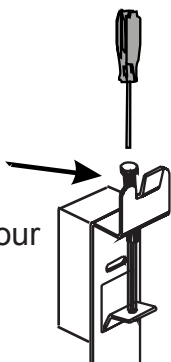

7

Cordon de l'appareil

RÉSEAU 230 V

Bleu ou Gris

Marron

Terre (Vert et jaune)

NEUTRE

PHASE

TERRE

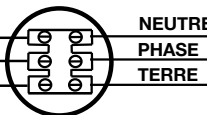

8

L'interrupteur
ON / OFF,
situé dans la
partie posté-
rieure droite
de l'appareil.

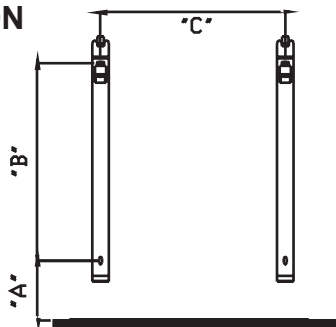
**INFORMATION**

(W)	"A" (mm)	"B" (mm)	"C" (mm)
600	420	246	159
900	420	246	319
1200	420	246	478
1500	420	246	638
1800	420	246	638

3.1 PANNEAU DE COMMANDE

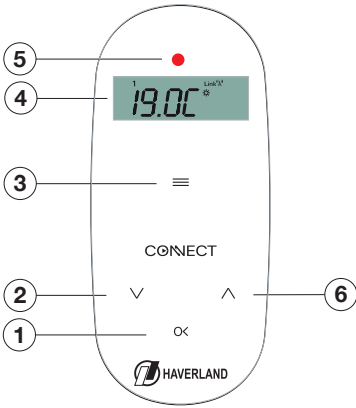

1. Touche Changement mode / OK
2. Touche Diminuer
3. Touche Configurer / Programmer
4. Écran
5. Indicateur Led "en fonctionnement"
6. Touche augmenter



Icones Écran

1 2 3 4 5 6 Jour semaine

88:88 Temp./Heure

Link (A) Radiateur associé

☀ ☾ * Températures

🕒 Fonction ITCS

🪟 Fonction fenêtres ouvertes

AUTO Auto

👤 Manuel

OFF Stand-by

FP Fil Pilote

AWAY GPS

3.2 DÉMARRAGE – PREMIÈRE CONNEXION

Au moment où l'émetteur est connecté au réseau électrique et que vous appuyez sur l'interrupteur situé sur le côté droit :

1. Si c'est la première fois, "Pr:Hd" s'affiche à l'écran.
2. Appuyer sur la touche (OK) Ci-dessous, vous voyez l'heure qui s'affiche et "OFF" désactivé.

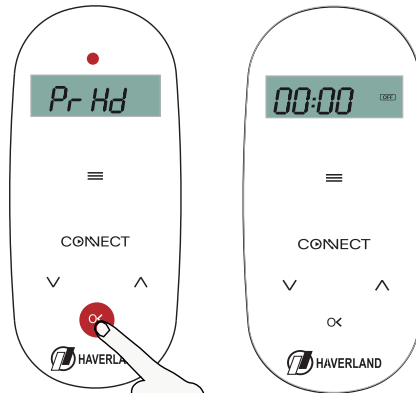

3.3 MODE DE FONCTIONNEMENT

L'appareil dispose de 3 modes de fonctionnement : OFF, AUTO (PRO) ou MANUEL.

En appuyant successivement sur la touche , l'écran passera du mode "OFF" au "mode AUTO" (PRO) puis au mode "MANUEL".

Appuyez successivement sur la touche  pour changer de mode de fonctionnement

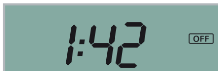

OFF

Mode
OFF

AUTO

Mode
Auto

Mode
Manual

La couleur du fond d'écran change lorsque la température de consigne est modifiée ou varie, pour indiquer à l'utilisateur la plage de température sélectionnée et s'affiche en :

- **Rojo** si la température est supérieure à 24°C
- **Amarillo** si elle est comprise entre 19°C et 24°C
- **Verde** si elle est inférieure ou égale à 19°C

3.4 MODE OFF

Appuyez sur la touche  jusqu'à ce que  s'affiche à l'écran. L'appareil reste TOUJOURS éteint.



3.5 MODE AUTO (PRO)

Appuyez sur la touche  jusqu'à ce que **PRO** et **AUTO** s'affiche à l'écran.

La température de consigne varie automatiquement selon la programmation personnalisable basée sur 3 températures de consigne (Confort, Éco, Hors-gel) ou la position OFF.



En mode Auto on peut augmenter ou diminuer la température temporairement. Cette modification temporaire se maintient jusqu'au prochain changement de programmation ou lorsqu'on passe au lendemain.





La plage de température en mode auto est comprise entre 5 °C et 30°C.

3.5.1 PROGRAMMATION HORAIRE :

Pour une utilisation efficace de votre radiateur, nous vous recommandons d'utiliser le mode AUTO (PRO). Programmez votre appareil aux heures spécifiques où la pièce a besoin d'être chauffée.

Le radiateur vous permet de programmer l'une des 3 températures possibles à chacune des heures ou de le mettre en mode OFF. La programmation peut être différente chaque jour.

- Température Confort  : pour les heures pendant lesquelles vous vous trouvez à votre domicile.
- Température Éco  pour les heures de nuit ou les courtes périodes d'absence du domicile.
- Température Hors-gel  pour les périodes d'absence prolongée.
- OFF **OFF** : Lorsque vous souhaitez programmer des périodes de déconnexion de l'appareil.

3.5.2 RÉGLAGE DE L'HEURE :

ACTION

1 Appuyez sur la touche  pendant **3 secondes**. Le jour clignote.

2 Appuyez sur les touches  . Appuyez sur  pour valider.

1	2	3	4	5	6	7
LUNDI	MARDI	MERCREDI	JEUDI	VENDREDI	SAMEDI	DIMANCHE

3 Puis, de la même manière, réglez l'heure et les minutes. Appuyez sur  pour quitter le menu "Réglage de l'heure".

ÉCRAN

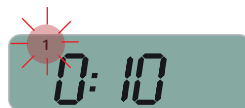

3.5.3 PROGRAMMATION HEBDOMADAIRE :

En fonction de vos besoins, le radiateur dispose de 4 options pour effectuer une programmation hebdomadaire.

OPTION 1 : TOUS LES JOURS AVEC UNE PROGRAMMATION DIFFÉRENTE.

Configurer chaque jour de la semaine avec une programmation différente.

**OPTION 2 : MÊME PROGRAMMATION POUR TOUS LES JOURS DE LA SEMAINE.**

La programmation configurée pour le lundi se répète pour les autres jours de la semaine.

**OPTION 3 : PROGRAMMATION JOURS OUVRABLES ET WEEK-END.**

D'abord, il est programmé avec le même horaire du lundi au vendredi, puis le week-end avec une programmation différente.

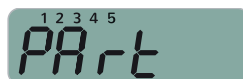









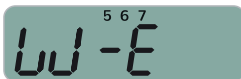









3. FONCTIONNEMENT

FR

OPTION 4 : PROGRAMMATION WEEK-END. IDÉALE POUR LES RÉSIDENCES SECONDAIRES.

Il est automatiquement en mode OFF du lundi au vendredi et la même programmation est configurée pour le vendredi, samedi et dimanche.





ACTION	ÉCRAN
<p>1 Appuyez sur la touche  pendant 3 secondes.</p>	
<p>2 Appuyez sur  pour quitter le menu "Réglage de l'heure" et entrer dans le menu "Option de programmation".</p>	
<p>3 Appuyez sur les touches   pour choisir l'option de programmation souhaitée ONE, ALL, PART ou WE.</p> <p>Appuyez sur e  pour confirmer.</p>	
<p>L'heure 0:00 et le jour 1 sont sélectionnés. Si le programme a déjà été configuré, la dernière modification s'affichera.</p> <p> La programmation par défaut d'usine est tous les jours et toutes les heures en mode économie.</p>	
<p>4 Appuyez successivement sur  pour choisir le mode souhaité pour une heure du jour 1 :</p> <p>Hors-gel  , économie  , confort  ou OFF .</p>	 <p>Hors-gel</p>  <p>Économie</p>  <p>Confort</p>  <p>OFF</p>

ACTION

ÉCRAN

- 5 Appuyez sur les touches   pour avancer ou reculer à l'heure suivante.



Un appui long sur les touches  ou  avance ou recule rapidement les heures sans modifier la programmation.



- 6 Appuyez successivement sur  pour choisir le mode souhaité pour l'heure 1:00 du jour 1 :

Hors-gel , économie , confort  ou OFF .

Répétez le processus pour chaque heure et pour le jour à configurer, en fonction de l'option de programmation choisie.



Un appui pendant 3 secondes sur la touche , et vous pourrez copier le mode choisi, confort, économie, hors-gel ou standby, de l'heure précédente.



En appuyant sur la touche  et vous pourrez passer au jour suivant quitter le menu programmation.



La led au dessus de l'écran s'allume lorsque le radiateur chauffe.



En mode AUTO (PRO), le mot PRO et la température de consigne choisie seront affichés alternativement sur l'écran, en fonction du mode sélectionné confort, économie ou hors-gel.













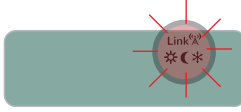





3.5.4 COMMENT CHANGER LES TEMPÉRATURES DE CONSIGNE?

En mode AUTO (PRO) les températures de consigne (confort, économie et antigel) changeront automatiquement en fonction de la programmation établie par l'utilisateur, qui attribuera à chaque heure l'une des quatre possibilités :

Hors-gel ❄️, économie 🌙, confort ☀️ ou OFF [OFF].

Pour établir les valeurs des trois températures :

ACTION	ÉCRAN
<p>1 Appuyez sur . Les symboles suivants s'affichent à l'écran :</p> <p>Par défaut, l'option pour définir les températures est déjà sélectionnée (clignotant).</p> <p>Appuyez sur la touche .</p>	
<p>2 Une fois sur l'écran de choix de températures, l'icone de confort ☀️ s'affiche avec la valeur en cours attribuée.</p> <p>Appuyez sur les touches   pour choisir la température de confort souhaitée.</p> <p>Appuyez sur  pour pouvoir choisir la température économie.</p>	
<p>Appuyez sur les touches   pour choisir la température économie souhaitée.</p> <p>Appuyez sur  pour pouvoir choisir la température hors-gel.</p>	
<p>Appuyez sur les touches   pour choisir la température antigel souhaitée.</p> <p> La température hors-gel peut être réglée entre 5 et 7°C.</p> <p>Appuyez sur  pour confirmer.</p> <p>Pour quitter le menu, appuyez sur la touche .</p>	



La couleur du fond d'écran change lorsque la température de consigne est modifiée ou varie, pour indiquer à l'utilisateur la plage de température sélectionnée et s'affiche en :







- **Rouge** si la température est supérieure à 24°C
- **Jaune** si elle est comprise entre 19°C et 24°C
- **Vert** si elle est inférieure ou égale à 19°C



Le réglage des températures de confort et d'économie peut se faire entre 7°C et jusqu'à 30°C, en tenant compte du fait que la température d'économie sera **TOUJOURS DE 2 °C AU-DESSOUS** de la température de confort sélectionnée et la température d'économie sera **TOUJOURS DE 2 °C AU-DESSUS** de la température hors-gel sélectionnée.

3.6 MODE MANUAL

En mode manuel, le radiateur fonctionne comme un thermostat d'ambiance.

ACTION	ÉCRAN
<p>1 Sélectionnez le mode manuel en appuyant sur la touche  jusqu'à ce que le symbole "main"  s'affiche à l'écran. La température qui s'affiche à l'écran est la température sélectionnée préalablement en mode manuel.</p> <p> La température d'usine par défaut, en mode manuel, est de 19 °C.</p>	
<p>2 Appuyez sur les touches   pour choisir la température souhaitée, par exemple, 21 °C.</p>	





La led située au dessus de l'écran s'allume lorsque le radiateur chauffe.



La température sélectionnée en mode manuel n'est pas liée à la température de confort. Ce sont des températures indépendantes et doivent donc être configurées séparément.

3.7 VERROUILLAGE DU CLAVIER

Appuyez simultanément sur les touches  et  jusqu'à ce que le mot **LoCH** s'affiche à l'écran.

Vous devez effectuer la même opération pour déverrouiller le clavier.



“LoCH” s'affiche à l'écran si le clavier est verrouillé.

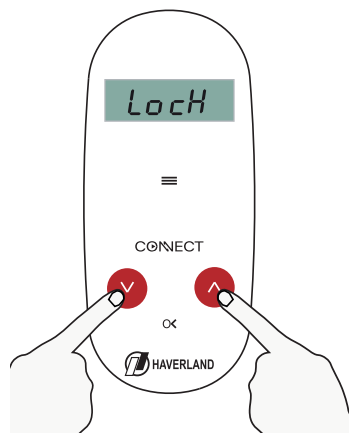

3 secondes

3.8 FONCTION “BOOST” - FONCTION 2 HEURES

Cette fonction met l'appareil en marche à pleine puissance pendant deux heures, quel que soit le mode de fonctionnement sélectionné. Cette fonction a la priorité sur n'importe quelle autre fonction.

Pour activer cette fonction, appuyez simultanément sur les touches  et  jusqu'à ce que “bSt” s'affiche à l'écran.

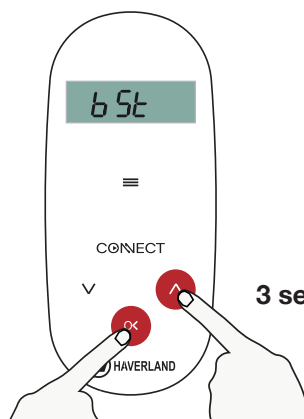

3 secondes



Lorsque vous activez cette fonction, “bSt” s'affiche à l'écran.

Vous pouvez désactiver la fonction “Boost” avant la fin des 2 heures, en appuyant sur n'importe quelle touche.

3.9 FONCTION ÉCONOMIE “FENÊTRES OUVERTES”

Cette fonction est activée en cas de chute soudaine de température dans la pièce.



Lorsque vous activez cette fonction, le symbole  s'affiche à l'écran.

L'appareil s'éteint pour éviter une consommation d'énergie inutile.



Lorsque vous fermez la fenêtre, le radiateur détectera une augmentation de température et cette fonction sera désactivée.

L'appareil se rallume pour revenir à l'état précédent la déconnexion.



Cette fonction intelligente est activée par défaut. Elle peut être désactivée par l'utilisateur ; voir point 3.11 “Fonctions avancées”.

3.10 FONCTION INTELLIGENTE ITCS

Le radiateur intègre un **système innovant de contrôle intelligent de la température ITCS**.

Ce système active la mise en marche de l'appareil **avant l'heure programmée** (2 heures maximum), afin de s'assurer que la température souhaitée est atteinte à l'heure indiquée et selon la programmation hebdomadaire établie.



Lorsque cette fonction est activée, le symbole,  s'affiche à l'écran.



Cette fonction intelligente est désactivée par défaut. Elle peut être activée par l'utilisateur ; voir point 3.11 “Fonctions avancées”.

3.11 FONCTIONS AVANCÉES

Ce radiateur intègre les fonctions suivantes :

Función	Ajuste
C1 Réglage en °C ou °F	Permet de changer les degrés Celsius en degrés Fahrenheit.
C2 Réglage du type de commande (PID, hystérésis, etc.).	Cette fonction est destinée aux utilisateurs ayant des connaissances en électronique. Veuillez ne pas entrer dans cette fonction; vous risquez de déconfigurer l'appareil.
C3 Réglage de la mesure de température	Permet de calibrer et d'ajuster la température mesurée par le thermostat.
C4 Version du firmware	Numéro de version du firmware de l'appareil.
C5 Activation / Désactivation fonction fenêtres ouvertes	Permet d'activer ou désactiver la fonction fenêtres ouvertes. Par défaut, la fonction est activée.
C6 Activation / Désactivation fonction ITCS	Permet d'activer ou désactiver la fonction ITCS. Par défaut, la fonction est désactivée.
C7 Activation / Désactivation fonction "Fil Pilote"	Permet d'activer ou désactiver la fonction "Fil Pilote". Par défaut, la fonction est désactivée. Cette fonction est seulement disponible en France.

ACTION

ÉCRAN

1 Appuyez sur .









2 Rappuyez sur la touche  pendant 5 secondes. Ensuite, le premier réglage, C1 s'affiche à l'écran.



3 Appuyez sur   pour sélectionner le réglage que vous souhaitez modifier (C1 à C7), par exemple C6.



Appuyez su  para entrar en el ajuste que se desea modificar.

ACTION	ÉCRAN
<p>4 Appuyez sur les touches   pour modifier réglage sélectionné.</p>	
<p>5 Appuyez sur  pour confirmer le réglage. Vous quittez automatiquement le menu de configuration avancée.</p>	
<p>6 Appuyez sur la touche  pour sortir.</p>	

3.12 DÉCONNEXION DU RÉSEAU ÉLECTRIQUE / COUPURE D'ÉLECTRICITÉ

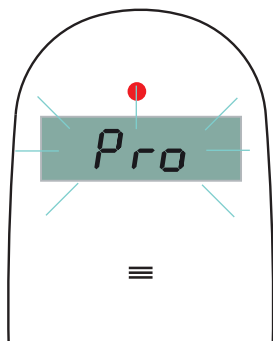

Si le radiateur est déconnecté du réseau électrique (par exemple, interrupteur de l'appareil déconnecté) ou en cas de coupure d'électricité **supérieure à 30 minutes**, "Pr:Hd" s'affiche à l'écran et **l'écran se met à clignoter**.

Vous devez configurer l'heure et le jour selon le point 3.5.2 RÉGLAGE DE L'HEURE.

Les autres paramètres programmés sont conservés en mémoire.

3.13 HAVERLAND APP

Pour commander toutes les fonctions de vos radiateurs, vous avez besoin d'une notre application gratuite Haverland App.

Vous pourrez télécharger gratuitement notre application Haverland



sur AppleStore o u

1 Veuillez suivre les indications de l'assistant de l'application.

2 Une fois que vous êtes enregistré dans notre système, appuyez sur **“+ SÉRIE CONNECT”**.

Ensuite, pour ajouter l'appareil à l'app, appuyez sur la touche  votre radiateur jusqu'à ce que le voyant de l'écran clignote.



3 Sélectionnez votre réseau wifi et entrez votre mot de passe. Commencez le processus d'installation avec votre radiateur.



- 4 Après avoir effectué cette étape, l'indicateur Link[®] s'affichera sur l'écran de votre radiateur.

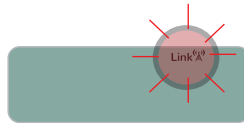

- 5 L'appareil est correctement lié. Répétez à partir du point 2 avec chaque radiateur que vous avez.

4. ENTRETIEN

Votre appareil ne nécessite aucun entretien particulier.

Nettoyez uniquement la poussière qui peut s'accumuler avec un chiffon sec et doux.

Il est recommandé, au début de la saison hivernale, de nettoyer la poussière accumulée sur la surface du radiateur.



NE JAMAIS UTILISER DE SOLVANTS OU DE PRODUITS ABRASIFS.

- **Leia as instruções de montagem.**
- Para desligar o emissor térmico da rede elétrica, retire a ficha de alimentação da tomada. **Nunca puxe o cabo.**
- Não deixe o cabo de ligação em contacto com o aparelho enquanto este estiver aceso.
- **A garantia do aparelho não cobre o não cumprimento das instruções.**



PERIGO: Não tape o aparelho. Não o use para secar roupa. Se o cobrir, corre o risco de um sobreaquecimento.



• **PERIGO: Se o cabo de alimentação estiver danificado, deve ser substituído pelo fabricante ou pelo serviço pós-venda.**



• **PERIGO: Num quarto de banho, o aparelho deve ser instalado de forma a não poder tocado por qualquer pessoa que se encontre na banheira ou duche.**



• **A instalação deve ser realizada levando em consideração estas instruções e de acordo com a legislação elétrica vigente.**

• Durante o funcionamento deve ter-se em atenção manter o aparelho afastado das matérias inflamáveis, tais como, cortinas, tapetes, móveis, etc.

• Verifique se o emissor está desligado antes de realizar qualquer operação no seu interior.

• Este aparelho deve ser ligado á terra.

• **O emissor deve ser instalado de tal maneira que a ficha de ligação esteja sempre acessível. Este emissor não se deve encastrar. Deve-se respeitar sempre as distâncias de segurança.**

• **O emissor dispõe de um bloqueio para evitar que as crianças alterem a programação.**

• Este aparelho não foi concebido para utilização por pessoas (incluindo crianças) com capacidades físicas, sensoriais ou mentais diminuídas nem com experiência ou conhecimento reduzido, exceto

sob supervisão de um responsável pela sua segurança com as instruções de utilização do aparelho. As crianças devem ser vigiadas para garantir que não brincam com o aparelho.

- As crianças com menos de 3 anos devem ser mantidas fora do alcance do aparelho, caso contrario devem estar supervisionadas permanente.
- As crianças com mais de 3 e menos de 8 anos devem só podem ligar/desligar o aparelho (on/off), se este estiver colocado ou instalado na posição de funcionamento defenitiva, se estiverem supervisionadas ou tenham recebido instruções de como usar o aparelho de forma segura e entenderam os riscos que o aparelho envolve.
- As crianças com mais de 3 anos e menos de 8 anos não devem ligar o aparelho na tomada de rede electrica, regular, limpar o aparelho ou realizar operações de manutenção.
- Este aparelho pode ser utilizado por crianças maiores de 8 anos e por pessoas com capacidades físicas, sensoriais ou mentais reduzidas, com pouca experiência ou conhecimento, desde que tenham sido devidamente treinados e são supervisionados por um adulto que conheça os riscos envolvidos.
- A limpeza e a manutenção deve efectuada por pessoas adultas não por crianças. As crianças não devem brincar com o aparelho.
- Deve ter-se um especial cuidado quando estão presentes crianças e pessoas com algum tipo de vulnerabilidade ou deficiência.



• **PERIGO: Algumas peças deste produto podem ficar muito quentes e causar queimaduras.** Deve prestar especial atenção na presença de crianças e de pessoas vulneráveis.



- **PERIGO:** Mantenha os sacos e os restantes acessórios incluídos fora do alcance das crianças.
- Evite tocar nas partes exteriores do emissor durante o funcionamento.
- É normal que na primeira colocação em funcionamento o aparelho liberte um cheiro “a novo”. Deixe o emissor funcionar num local ventilado durante duas ou três horas.
- O emissor **NÃO pode funcionar** com centrais externas de control.
- Antes de cada inverno ou depois de vários dias de inatividade, limpe

o aparelho antes de o ligar (siga os passos da secção 4 - Manutenção). Com esta limpeza evitará queimar o pó acumulado e outros resíduos.

- Durante o funcionamento do emissor a convecção emitida junto com outros fatores ambientais podem descolorar as superfícies metálicas.
- Mudanças bruscas de temperatura ambiente podem provocar “estalidos” e/ou ruidos no emisor. Isto não é indicativo de avaria no emisor.
- Deve ter em conta os requisitos estabelecidos pela legislação para o tratamento e reciclagem de resíduos quando deite o aparelho fora.

**IMPORTANTE**

- É indispensável que o emissor **SEJA FIXADO FIRMEMENTE A UMA PAREDE FIXA E NIVELADA.**
- Verifique se há alguma tomada perto de onde o vai colocar.
- Tire de dentro de caixa o escantilhão onde se indica a posição exacta dos furos.
- Para evitar problemas é necessária uma distância mínima de 15 cm entre o emissor e qualquer.

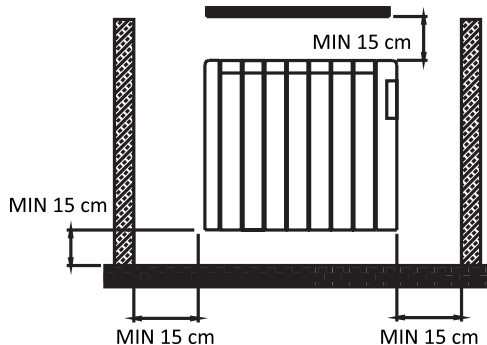

2. INSTRUÇÕES DE INSTALAÇÃO

P

1

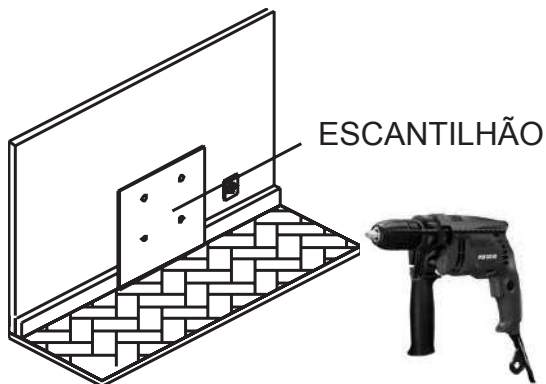

2

APONTE O
PARAFUSO ATÉ QUE
TOQUE NA PATILHA
INFERIOR
(M. 6 x 40 mm)

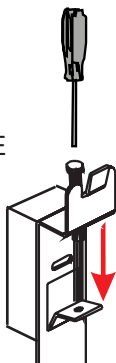

3

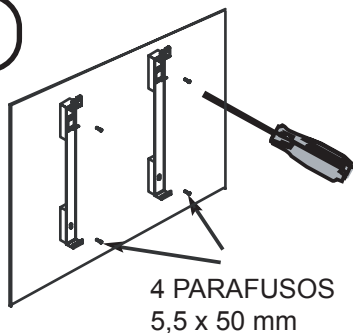

4

APOIE O
EMISSOR

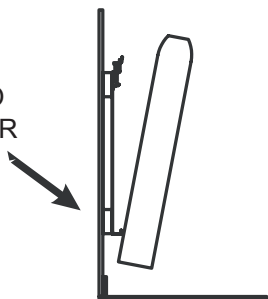

5

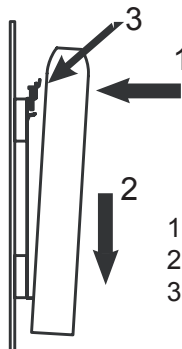

1. DESLOQUE
2. CAIR
3. APOIE

6

**IMPORTANTE:**

TERMINE DE
APARAFUSAR
PARA FIXAR
O EMISSOR

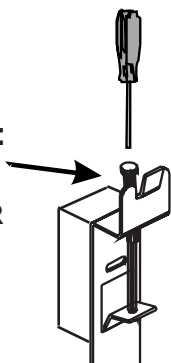

7

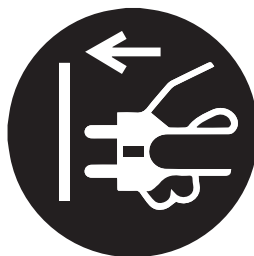

8

Carregue no interruptor ON/
OFF, que se encontra na
parte posterior
direita do apa-
relho.

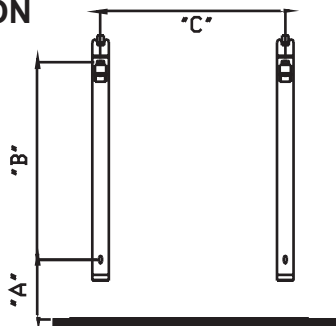
**INFORMACIÓN**

(W)	"A" (mm)	"B" (mm)	"C" (mm)
600	420	246	159
900	420	246	319
1200	420	246	478
1500	420	246	638
1800	420	246	638

3.1 PAINEL DE CONTROLO

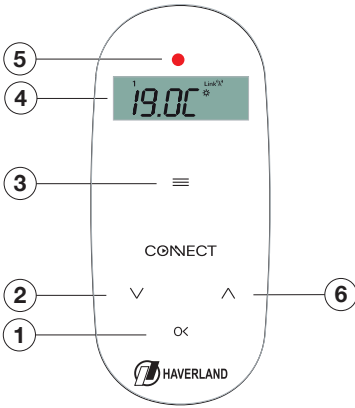

1. Tecla Alterar modo / OK
2. Tecla Diminuir
3. Tecla Configurar / Programar
4. Visor
5. Led indicador “em funcionamento”
6. Tecla aumentar



Ícones Visor

1 2 3 4 5 6 Dia semana

88:88 Temp./Hora

Link Radiador associado

Temperaturas

Função ITCS

Função janelas abertas

AUTO Auto

Manual Manual

OFF Stand-by

FP Fio Piloto

AWAY GPS

3.2 INÍCIO - PRIMEIRA LIGAÇÃO

Quando do emissor é ligado à rede elétrica e se liga o interruptor situado na parte lateral direita:

1. Se for a primeira vez, o visor mostra a mensagem “Pr:Hd”.
2. Pressionar a tecla . A seguir é mostrado o relógio desligado “OFF”.

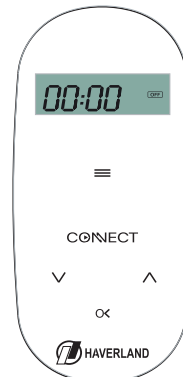
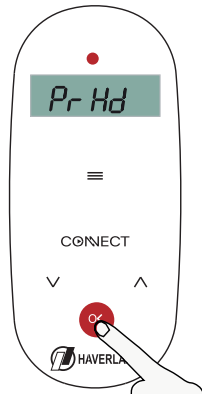

3.3 MODO DE FUNCIONAMENTO

O equipamento tem 3 modos de funcionamento: OFF, AUTO (PRO) ou MANUAL.

Pressionando sucessivamente a tecla , o emissor muda do modo "OFF" para o "modo AUTO" (PRO) e para o modo "MANUAL".

Pressionar a tecla  para mudar de modo de funcionamento

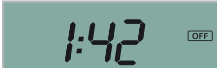

OFF

Modo
OFF



AUTO

Modo
Auto



Modo
Manual



A cor de fundo do visor muda quando as definições de temperatura são alteradas, indicando ao utilizador o intervalo de temperatura selecionado e o mostrado a:

- **Vermelho** se a temperatura for superior a 24°C
- **Amarelo** se situar entre 19°C e 24°C
- **Verde** se for igual ou inferior a 19°C

3.4 MODO OFF

Pressione a tecla  até que apareça  no visor. O equipamento mantém-se SEMPRE desligado.

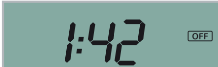

3.5 MODO AUTO (PRO)

Pressione a tecla  até que apareça *Pro* e **AUTO** no visor.

A temperatura predefinida varia automaticamente conforme a programação personalizável com base em 3 temperaturas predefinidas (Conforto, Eco, Anti gelo) ou o modo OFF.



No modo Auto é possível subir ou descer a temperatura temporariamente. Esta alteração mantém-se até à próxima alteração na programação ou por alteração no dia seguinte.





O intervalo da temperatura no modo auto vai de 5°C a 30°C.

3.5.1 PROGRAMAÇÃO HORÁRIA:

Para uma utilização eficiente do seu radiador, recomendamos usar o modo AUTO (PRO). Programe o seu equipamento indicando o tempo exato de aquecimento da divisão da casa.

O radiador permite atribuir uma das 3 temperaturas possíveis a cada uma das horas ou desligá-lo (OFF). A programação pode ser diferente para cada dia.

- Temperatura conforto : para as horas em que está em casa.
- Temperatura economia : durante a noite ou para curtos períodos de ausência de casa.
- Temperatura anti gelo : para períodos de ausência prolongados.
- OFF **OFF**: Quando pretende definir períodos em que o equipamento vai estar desligado.

3.5.2 ACERTO DIA E HORA:

AÇÃO

1 Prima a tecla  durante 3 segundos. O dia fica intermitente.

2 Pressione as teclas   para definir. Pressione  para validar.

1	2	3	4	5	6	7
SEGUNDA-FEIRA	TERÇA-FEIRA	QUARTA-FEIRA	QUINTA-FEIRA	SEXTA-FEIRA	SÁBADO	DOMINGO

3 Em seguida, da mesma forma, defina a hora e os minutos. Pressione  para sair do menu “Acerto dia e hora”.

VISOR

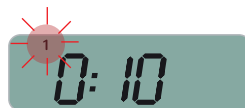

3.5.3 PROGRAMAÇÃO SEMANAL

Conforme as suas necessidades, o radiador dispõe de 4 opções para proceder à programação semanal.

OPÇÃO 1: TODOS OS DIAS COM DIFERENTE PROGRAMAÇÃO.

Defina uma programação diferente para cada dia da semana.

**OPÇÃO 2: MESMA PROGRAMAÇÃO TODOS OS DIAS DA SEMANA.**

A programação que está definida para segunda-feira, repete-se durante o resto da semana.

**OPÇÃO 3: PROGRAMAÇÃO DURANTE A SEMANA E FIM DE SEMANA.**

Primeiro programam-se os dias da semana, de segunda a sexta-feira com a mesma programação e, em seguida, o fim de semana com uma programação diferente.

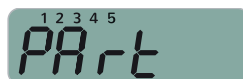

3. FUNCIONAMENTO

P

OPÇÃO 4: PROGRAMAÇÃO DE FIM DE SEMANA. IDEAL PARA UMA SEGUNDA CASA.

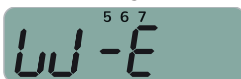

Automaticamente é definido o modo OFF de segunda a quinta-feira e configura-se a mesma programação para sexta-feira, sábado e domingo.



AÇÃO

- 1 Pressione a tecla  durante 3 segundos. O dia fica intermitente.

- 2 Pressione  sair do menu “Acerto dia e hora” e entrar no menu de seleção “Opção de programação”.

- 3 Pressione as teclas   para escolher a opção de programação desejada ONE, ALL, PART ou WE. Pressione  para validar.

Está selecionada a hora 0:00 e o dia 1. Se o programa tiver sido configurado anteriormente é apresentada a alteração mais recente.



De fábrica, o equipamento encontra-se no modo economia para todos os dias e horas.

- 4 Pressione sucessivamente a tecla  para selecionar o modo desejado para aquela hora do dia 1:

Anti-gelo , economia , conforto  ou OFF .

VISOR

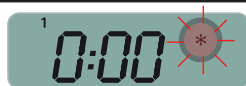

Anti-gelo

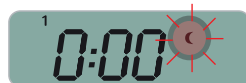

Economia



Conforto





OFF

P

AÇÃO

- 5 Pressione as teclas   para avançar ou retroceder para a próxima hora.



Pressionar as teclas prolongadamente,  ou , avança ou retrocede as horas sem alterar a programação.

- 6 Pressione sucessivamente a  para escolher o modo pretendido para a hora 1:00 do dia 1:

Anti gelo , economia , conforto  ou OFF .

Repita o processo para cada hora e dia a definir, de acordo com a opção de programação escolhida.

VISOR



Manter a tecla pressionada  durante 3 segundos pode copiar o modo, conforto, economia, anti gelo ou standby da hora anterior.



Pressionar a tecla  pode avançar o dia e sair do menu programação.



O led na parte superior do visor acende quando o radiador está a aquecer.



No modo AUTO (PRO) é exibida no visor alternadamente a palavra PRO e a temperatura escolhida, consoante se encontra no modo conforto, economia ou anti gelo.











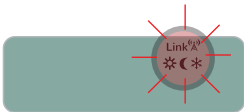

3.5.4 COMO ALTERAR AS TEMPERATURAS PREDEFINIDAS?

No modo AUTO (PRO) as temperatura predefinidas (conforto, economia, anti gelo) mudam automaticamente de acordo com a programação definida pelo utilizador,

Anti gelo ❄️, economia 🌙, conforto ☀️ ou OFF [OFF].

Para definir os valores das três temperaturas:

AÇÃO	VISOR
<p>1 Pressione a tecla . Aparecem os seguintes símbolos no visor:</p> <p>Por defeito a opção definir temperaturas aparece já selecionada (intermitente).</p> <p>Pressione a tecla .</p>	
<p>2 No visor de seleção da temperatura aparece o ícone de conforto ☀️ e o valor predefinido no momento.</p> <p>Pressione as teclas   para escolher a temperatura de conforto desejada.</p> <p>Pressione a tecla  para escolher a temperatura de economia.</p>	
<p>Pressione as teclas   para escolher a temperatura de economia desejada.</p> <p>Pressione a tecla  para escolher a temperatura anti-gelo.</p>	
<p>Pressione as teclas   para escolher a temperatura de anti-gelo desejada.</p> <p> A temperatura anti gelo pode ser definida entre 5 e 7°C.</p> <p>Pressione a tecla  para confirmar.</p> <p>Para sair do menu, pressione a tecla .</p>	



A cor de fundo do visor muda quando as definições de temperatura são alteradas, indicando ao utilizador o intervalo de temperatura seleccionado e é mostrado a:







- **Vermelho** se a temperatura seleccionada for superior a 24°C
- **Amarelo** se se situar entre 19°C e 24°C
- **Verde** se for igual ou inferior a 19°C



A definição das temperaturas conforto e economia pode fazer-se entre 7°C e 30°C, tendo em conta que a temperatura do modo economia É **SEMPRE 2°C MAIS BAIXA** do que a temperatura do modo conforto seleccionada e a temperatura de economia É **SEMPRE 2°C SUPERIOR** à temperatura anti gelo seleccionada.

3.6 MODO MANUAL

No modo manual, o radiador funciona como um termóstato de ambiente.

AÇÃO	VISOR
<p>1 Selecione o modo manual pressionando a tecla  até que apareça no visor o símbolo “mão”  .</p> <p>A temperatura mostrada no visor é a temperatura selecionada previamente no modo manual.</p> <p>i A temperatura predefinida de fábrica, no modo manual, é de 19°C.</p>	
<p>2 Pressione as teclas   para escolher a temperatura desejada, por exemplo, 21°C.</p>	





O led na parte superior do visor acende quando o radiador está a aquecer.



A temperatura selecionada no modo manual não está associada à temperatura de conforto. São temperaturas independentes e, portanto, devem ser configuradas separadamente.

3.7 BLOQUEIO DO TECLADO

Pressione simultaneamente as teclas  e  até aparecer no visor a palavra **LoCH**.

Deve efetuar a mesma operação para desbloquear o teclado.



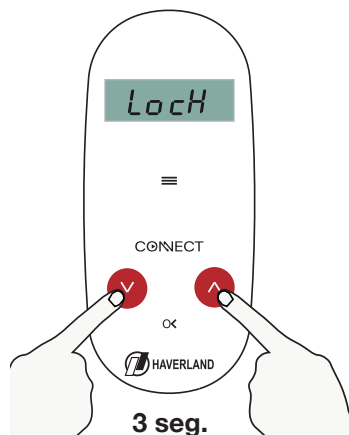

Aparece **“LoCH”** no visor, se o teclado estiver bloqueado.



3.8 FUNÇÃO “BOOST” - FUNÇÃO 2 HORAS

Esta função coloca o equipamento em funcionamento na potência máxima durante duas horas, independentemente do modo que estiver selecionado. Esta função tem prioridade sobre qualquer outra.

Para ativar esta função pressione simultaneamente as  e  teclas **“bSt”** no visor.

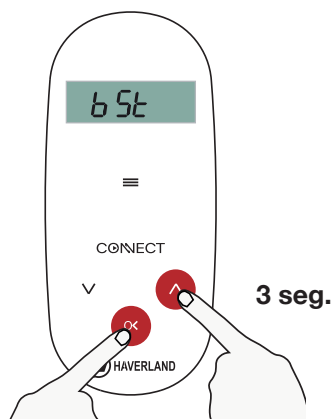

Ao ativar esta função, aparece **“bSt”** no visor.

A função “Boost” pode ser desativada antes de terminarem as 2 horas, pressionando qualquer tecla.

3.9 FUNÇÃO ECONOMIA “JANELAS ABERTAS”

Esta función se activa cuando se produce un descenso brusco de la temperatura en la habitación.



Quando esta função é ativada, aparece o símbolo  no visor. O equipamento desliga-se evitando um consumo desnecessário de energia.



Ao fechar a janela, o radiador deteta uma subida da temperatura e esta função é desativada. O equipamento liga-se novamente regressando ao estado antes de ser desligado.



Esta função inteligente vem desativada de fábrica. Pode ser ativada pelo utilizador, consulte a secção 3.11 “Funções avançadas”.

3.10 FUNÇÃO INTELIGENTE ITCS

O radiador inclui **um inovador sistema de controlo inteligente da temperatura ITCS**. Este sistema ativa o **arranque do aparelho antecipadamente à hora programada** (2 horas máximo), para garantir que obtém a temperatura desejada à hora indicada e seguindo a programação semanal definida.



Quando esta função está ativada, aparece o símbolo  no visor.

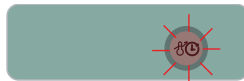





Esta função inteligente vem desativada de fábrica. Pode ser ativada pelo utilizador, consulte a secção 3.11 “Funções avançadas”.

3.11 FUNÇÕES AVANÇADAS

Este radiador incorpora las siguientes funciones:







Función	Ajuste
C1 Definição para °C ou °F	Permite mudar de graus Celsius para graus Fahrenheit.
C2 Configuração do tipo de controlo (PID, histerese, etc.).	Esta função destina-se a utilizadores com conhecimentos de eletrónica. Por favor, não entre nesta função; pode desconfigurar o equipamento.
C3 Definição da medição da temperatura.	Permite calibrar e ajustar a temperatura medida pelo termóstato.
C4 Versão firmware	O número da versão firmware do equipamento.
C5 Ativar / Desativar a função janelas abertas	Permite ativar ou desativar a função janelas abertas. Por defeito, a função está ativada.
C6 Ativar / Desativar a função ITCS	Permite ativar ou desativar a função ITCS. Por defeito, a função está desativada.
C7 Ativar / Desativar a função “filo piloto” (Fil Pilote)	Permite desativar ou ativar a função “filo piloto” (Fil Pilote). Por defeito, a função está desativada. Esta função está disponível apenas em França.

AÇÃO

- 1 Pressione a tecla .
- 2 Pressione novamente a tecla  durante 5 segundos. Em seguida, aparece no visor a primeira definição, C1.
- 3 Pressione as teclas   para seleccionar a definição que deseja alterar (C1 a C7), por exemplo, C6.
Pressione e  para aceder à configuração que deseja alterar.

VISOR



AÇÃO	VISOR
<p>4 Pressione as teclas   para alterar a definição selecionadas.</p>	
<p>5 Pressione  para confirmar a definição. Passa-se automaticamente para o menu de configuração avançada.</p>	
<p>6 Pressionar a tecla  para sair.</p>	

3.12 DESLIGAR DA REDE ELÉTRICA / CORTE ABASTECIMENTO

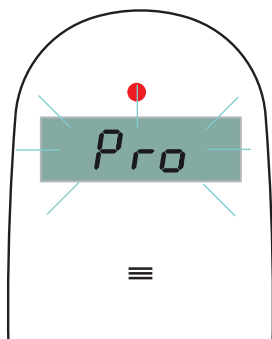

Se o radiador estiver desligado da fonte de alimentação (por exemplo, interruptor do transmissor desligado) ou se se verificar um corte no fornecimento de energia **superior a 30 minutos, no visor é mostrada a mensagem “Pr:Hd” e o visor pisca.**

Deve definir a hora e o dia seguindo o ponto 3.5.2 ACERTO DO DIA E HORA.

Os restantes parâmetros programados são mantidos na memória.

3.13 HAVERLAND APP

Para controlar todas as funções dos seus radiadores, através do smartphone ou tablet, é necessária nossa app gratuita Haverland. Pode fazer o download gratuito da nossa app Haverland na AppleStore ou em Google Play.



- 1 Siga o assistente que é indicado na app.
- 2 Depois de se registar no nosso sistema, pressione “+ SÉRIE CONNECT”. Em seguida, para adicionar o dispositivo à app, pressione a tecla  até que a luz do visor do radiador pisque.

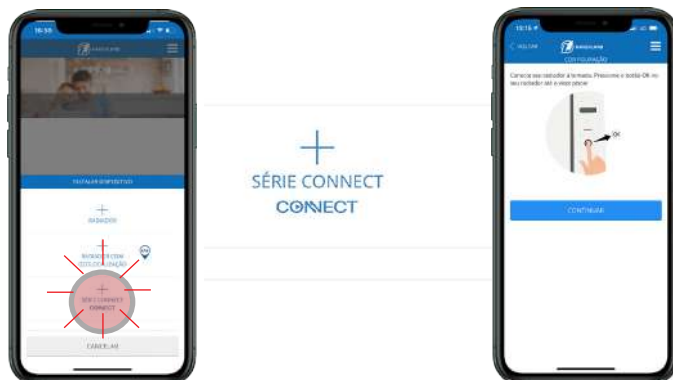

- 3 Selecione sua rede wi-fi e digite sua senha. O processo de configuração começará com o seu radiador.



- 4 Quando esta etapa estiver concluída, aparece no visor do radiador Link[®].

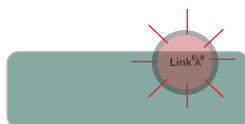

- 5 O dispositivo está conectado corretamente. Repita a partir do ponto 2 com cada radiador que você possui.

4. MANUTENÇÃO

O seu equipamento não requer qualquer manutenção especial.

Limpe apenas o pó que pode acumular-se usando um pano seco e macio.

É conveniente ao iniciar a temporada de inverno, limpar o pó acumulado na superfície do radiador.



NUNCA UTILIZE SOLVENTES OU PRODUTOS ABRASIVOS.

GARANTÍA

MARSAN INDUSTRIAL, S.A. garantiza la conformidad de los aparatos con las especificaciones del contrato.

Esta garantía cubre la reparación del aparato y comprenderá los gastos necesarios realizados para subsanar la falta de conformidad de los bienes con el contrato.

Dicha subsanación será garantizada durante un plazo de 24 meses desde la fecha de compra conforme a la factura contra cualquier defecto de fabricación y funcionamiento durante el uso normal y doméstico de este producto.

El coste del material (piezas y recambios) será garantizado durante un plazo de 36 meses y por 10 años la estanqueidad del cuerpo de aluminio desde la fecha de compra conforme a la factura.

Esta garantía ampara únicamente el aparato cuyo modelo esté anotado en la factura de compra.

Esta garantía NO CUBRE la instalación inadecuada, el mantenimiento, limpieza o conservación del aparato, así como tampoco las averías motivadas por fuerza mayor, agentes químicos o fenómenos atmosféricos, por uso indebido del aparato, por una instalación eléctrica del comprador defectuosa, transporte del aparato, ni por la manipulación del aparato por personal no autorizado por MARSAN INDUSTRIAL, S.A.

Esta garantía no debe ser modificada, alterada ni extendida, y el Fabricante NO autoriza a nadie a actuar en su nombre en la modificación, alteración o extensión de ésta.

Esta garantía se aplica al Producto solamente.

Para la reparación del aparato, el consumidor deberá dirigirse al Servicio de Asistencia Técnica al teléfono 91 324 40 60 (Horario: Lunes a Viernes de 9 a 20 h) o enviar un correo electrónico a postventa@haverland.com solicitando la información necesaria sobre el procedimiento a seguir.

Para la sustitución, cancelación o rebaja del precio, en su caso, el consumidor deberá dirigirse al establecimiento vendedor. Esta garantía no afecta a los derechos de que dispone el consumidor conforme a las previsiones dispuestas en la Ley 23/2003, de Garantía en la Venta de Bienes de Consumo.



Teléfono Atención al Cliente:
91 324 40 60 (L-V: 9 - 20 h)



E-mail: postventa@haverland.com



La presencia de este símbolo sobre alguno de nuestros productos eléctricos o embalajes de presentación, significa que tales productos no deben tratarse como residuos domésticos convencionales en Europa. Para garantizar el tratamiento adecuado de este tipo de residuos, deshágase de los mismos conforme a las leyes pertinentes o según los requisitos de desecho de equipamiento eléctricos. Al tomar esta iniciativa, estará ayudando a preservar el medio ambiente.

Marsan Industrial, S.A.
Avda. San Martín de Valdeiglesias, Km. 2,2
28925 Alcorcón (Madrid)
España

Fabricado en España

Marsan Industrial, S.A. se reserva el derecho a realizar modificaciones sin previo aviso

GUARANTEE

MARSAN INDUSTRIAL, S.A. guarantees that the devices comply with the contracted specifications.

This warranty only covers the model of heater showed on the valid invoice.

Such rectifications will be guaranteed against any manufacturing and operating defect for the normal and domestic use of this product, for a period of 24 months as from the purchase date shown on the invoice.

HAVERLAND guarantees against material, design or manufacturing faults at the moment of its original acquisition for 2 years. The electronic component and paintwork / finish for 3 years and 10 years for the aluminium body (exclude accidental damage, transport, and misuse).

This warranty only covers the device whose model appears on the purchase invoice.

This warranty DOES NOT COVER incorrect installation, maintenance, cleaning or conserving the device, and neither does it cover failures and faults due to force major, chemical agents or atmospheric phenomena, incorrect use of the device, the purchaser's faulty electrical installations, transporting the device or problems caused by the device being handled by persons not authorised by MARSAN INDUSTRIAL, S.A.

This warranty must not be modified, altered or extended, and the Manufacturer does not authorise anybody to act on his behalf to modify, alter or extend it.

This warranty applies only to the Product.

To repair the device, the consumer must dial the Technical Assistance Service at 0330 3651940 or send an email to haverland@haverland.co.uk and ask for the information needed about the procedure to follow:

For a replacement, cancellation or price reduction, when in order, the consumer must go the establishment where the device was purchased. This warranty does not affect the consumers' rights as established in the provisions contained In Law 23/2003, the Consumer Goods Sales Guarantee Act.



Customer Service Telephone:

0330 3651940



E-mail: haverland@haverland.co.uk



Where you see this symbol on any of our electrical products or packaging, it indicates that the relevant electrical product should not be disposed of as general household waste in Europe. To ensure the correct waste treatment of the product, please dispose of it in accordance with any applicable local laws or requirements for disposal of electrical equipment. In so doing, you will help to conserve natural resources and improve standards of environmental protection in treatment and disposal of electrical waste.

Haverland UK Limited
Challenge House
Sherwood Drive
Bletchley MK3 6DP

Made in Spain

Marsan Industrial, S.A. reserves the right to modify without previous warning

GARANTIE

MARSAN INDUSTRIAL, S.A. garantit que les appareils sont conformes aux spécifications du contrat.

Cette garantie couvre la réparation de l'appareil et comprendra les charges nécessaires encourues pour corriger la non-conformité des biens avec le contrat.

Cette correction sera garantie sur une durée de 24 mois après la date d'achat, selon la facture, contre tout défaut de fabrication et de fonctionnement au cours de l'usage normal et domestique de ce produit.

Le coût du matériel (pièces et pièces de rechange) sera garanti pendant une période de 36 mois et l'étanchéité du corps en aluminium, pendant 10 ans après la date d'achat selon la facture.

Cette garantie ne couvre que l'appareil dont le modèle est annoté sur la facture d'achat.

Elle NE COUVRE PAS l'installation incorrecte, l'entretien, le nettoyage ou la conservation de l'appareil, ni les pannes motivées par une cause de force majeure, des agents chimiques ou des phénomènes atmosphériques, par un usage indu de l'appareil, par une installation électrique de l'acheteur défectueuse, par le transport de l'appareil, ni par la manipulation de l'appareil par un personnel non agréé par MARSAN INDUSTRIAL, S.A.

Cette garantie ne doit être ni modifiée ni altérée ni étendue, et le Fabricant n'autorise personne à agir en son nom dans la modification, l'altération ou l'extension de celle-ci.

Cette garantie s'applique uniquement au Produit.

Pour la réparation de l'appareil, le consommateur devra s'adresser au Service d'Assistance Technique en contactant le + 34 91 324 40 60 (Horaire : du lundi au vendredi, de 9 h à 20 h) ou envoyer un email à postventa@haverland.com en sollicitant l'information nécessaire de la démarche à suivre.

Pour demander une substitution, une annulation ou un rabais, le cas échéant, le consommateur devra s'adresser à l'établissement vendeur. Cette garantie n'affecte pas les droits dont dispose le consommateur selon la Loi 23/2003, de Garantie dans la Vente de Biens de Consommation.



Téléphone Service Client:

+ 34 91 324 40 60 (L-V: 9 - 20 h)



E-mail: postventa@haverland.com



Quand vous voyez ce symbole sur l'un de vos produits électriques ou sur l'emballage, ceci veut dire que le produit électrique en question ne doit pas être jeté avec les ordures ménagères ordinaires en Europe. Pour garantir le traitement correct du produit en tant que déchet, veuillez vous en défaire conformément à la législation locale applicable ou aux prescriptions relatives à l'élimination des équipements électriques. De cette façon, vous aiderez à préserver de l'environnement.



Fabriqué en Espagne

Marsan Industrial, S.A.
Avda. San Martín de Valdeiglesias, Km. 2,2
28925 Alcorcón (Madrid)

Espagne

Fabriqué en Espagne

Marsan Industrial, S.A. se réserve le droit de réaliser des modifications sans avis préalable.

GARANTIA

A MARSAN INDUSTRIAL, S.A. garante a conformidade dos aparelhos com as especificações do contrato.

Esta garantia cobre a reparação do aparelho e compreende as despesas necessárias e realizadas para resolver a falta de conformidade dos bens com o contrato.

Esta resolução será garantida durante um prazo de 24 meses desde a data de compra segundo a fatura contra qualquer defeito de fabrico e funcionamento durante uma utilização normal e doméstica deste produto.

O custo do material (peças sobresselentes) será garantido durante um prazo de 36 meses e a estanquidade do corpo de alumínio possui uma garantia de 10 anos a partir da data de compra segundo a factura.

Esta garantia cobre unicamente o aparelho cujo modelo seja indicado na factura de compra.

Esta garantia NÃO COBRE uma instalação inadequada, a manutenção, a limpeza ou conservação do aparelho, as avarias causadas por força maior, agentes químicos ou fenómenos atmosféricos, por utilização indevida do aparelho, por instalação eléctrica do comprador defeituosa, por transporte do aparelho nem pela manipulação do aparelho por pessoal não autorizado pela MARSAN INDUSTRIAL, S. A.

Esta garantia não deve ser modificada, alterada nem ampliada e o Fabricante não autoriza ninguém a agir em seu nome para a modificação, alteração ou ampliação da mesma. Esta garantia aplica-se unicamente ao produto.

Para a reparação do aparelho, o consumidor deve contactar o Serviço de Assistência Técnica através do telefone + 34 91 324 40 60 (Horário: segunda a sexta das 09h00 às 20h00) ou enviar um correio electrónico para postventa@haverland.com, pedindo a informação necessária sobre o procedimento a seguir.

Para a substituição, anulação ou redução do preço, consoante o caso, o consumidor deve contactar o estabelecimento vendedor. Esta garantia não afeita os direitos do consumidor em conformidade com o disposto na Lei 23/2003, sobre a Garantia na Venda de Bens de Consumo.



Apoio ao Cliente:

+ 34 91 324 40 60 (L-V: 9 - 20 h)



E-mail: postventa@haverland.com



Quando encontra este símbolo em qualquer um dos nossos produtos eléctricos ou na respectiva embalagem isso indica que na Europa esse produto eléctrico não deve ser deitado fora juntamente com o lixo doméstico normal. Para assegurar o devido tratamento ecológico deste produto quando o deite fora, é favor acuar em conformidade com as leis ou regulamentos locais aplicáveis para a eliminação de equipamento eléctrico. Se assim o fizer contribui para a protecção ambiental.



Marsan Industrial, S.A.
Avda. San Martín de Valdeiglesias, Km. 2,2
28925 Alcorcón (Madrid)
Espanha

Fabricado em Espanha

Marsan Industrial, S.A. reserva-se o direito de realizar modificações sem aviso prévio

Modelos / Models / <i>Modèles / Modelos</i>	RCTT4C	RCTT6C	RCTT8C	RCTT10C	RCTT12C
Potencia calorífica / Heat output / <i>Puissance thermique / Potência calorífica</i>					
Potencia calorífica nominal (kW) Nominal heat output (kW) <i>Puissance thermique nominale (kW)</i> <i>Potência calorífica nominal (kW)</i>	0.6	0.9	1.2	1.5	1.8
Potencia calorífica máxima continuada (kW) Maximum continuous heat output (kW) <i>Puissance thermique maximale continue (kW)</i> <i>Potência calorífica continua máxima (kW)</i>	0.6	0.9	1.2	1.5	1.8
Consumo auxiliar de electricidad / Auxiliary electricity consumption / <i>Consommation d'électricité auxiliaire / Consumo de electricidade auxiliar</i>					
A potencia calorífica nominal (kW) At nominal heat output (kW) <i>À la puissance thermique nominale (kW)</i> <i>À potência calorífica nominal (kW)</i>	0.6	0.9	1.2	1.5	1.8
A potencia calorífica mínima (kW) At minimum heat output (kW) <i>À la puissance thermique minimale (kW)</i> <i>À potência calorífica mínima (kW)</i>	0.6	0.9	1.2	1.5	1.8
En modo de espera (kW) In standby mode (kW) <i>En mode veille (kW)</i> <i>Em estado de vigília (kW)</i>	<0,001	<0,001.	<0,001.	<0,001	<0,001
Tipo de control de temperatura interior Type of heat room temperature control <i>Type de contrôle de la température de la pièce</i> <i>Tipo de comando da temperatura interior</i>	Con control electrónico de temperatura interior y temporizador semanal Electronic room temperature control plus week timer <i>Contrôle électronique de la température de la pièce et programmeur hebdomadaire</i> <i>Com comando eletrónico da temperatura interior e temporizador semanal</i>				
Otras opciones de control	- Control de temperatura interior con detección de ventanas abiertas - Con control de puesta en marcha adaptable				
Other control options	- Room temperature control, with open window detection - With adaptive start control				
<i>Autres options de contrôle</i>	- <i>Contrôle de la température de la pièce, avec détecteur de fenêtre ouverte</i> - <i>Contrôle adaptatif de l'activation</i>				
<i>Outras opções de comando</i>	- <i>Comando da temperatura interior, com deteção de janelas abertas</i> - <i>Com comando de arranque adaptativo</i>				
Nombre del fabricante / Name del fabricante / <i>Nom du fabricant / Nome do fabricante</i>	Marsan Industrial, S.A.				
Dirección / Address / <i>Adresse / Endereço</i>	Avda. San Martín de Valdeiglesias, Km 2.2 28925 Alcorcón (Madrid) España / Spain / <i>Espagne / Espanha</i>				

RCTTC

CONNECT

	W	Nº 
RCTT4C	600	4
RCTT6C	900	6
RCTT8C	1200	8
RCTT10C	1500	10
RCTT12C	1800	12

230 V 50 Hz

CLASE I / CLASS I
CLASSE I

Google es una marca comercial de Google LLC.
Google is a trademark of Google LLC.
Google est une marque de Google LLC.
Google é uma marca registrada da Google LLC.