



Caution, Risk of fire
R290



EH1924

12,000BTU Mobile Portable Local Air Conditioner with
Remote Control and Timer

Please Retain for Future Reference

IMPORTANT

Installer and Users please note:

These instructions should be read carefully and left with the user of the product for future reference.

BEFORE USE

- Inspect the product (including its cable and plug) for any signs of damage; If the product is damaged in anyway **do not use it** and contact your supplier immediately.
- The product contains a refrigerant gas, so it **must be kept upright at all times**.
- After unpacking wait 3 hours for the refrigerant gas to stabilise before use.
- Insert 2 x 1.5v AAA batteries (not supplied) into the battery compartment of the remote control.

PRODUCT SAFETY

- **WARNING!** Appliance shall be installed, operated and stored in a room with a floor area larger than 12m²
- This appliance can be used by children aged from 8 years and above and persons with reduced physical, sensory or mental capabilities or lack of experience and knowledge if they have been given supervision or instruction concerning use of the appliance in a safe way and understand the hazards involved
- Children shall not play with the appliance
- Cleaning and user maintenance shall not be made by children without supervision.
- For indoor use only
- Do not use in bathrooms, wet rooms or other damp locations
- Do not use this product with an extension lead
- Use of this product in boats, caravans, mobile homes or other similar locations is forbidden
- There must be a minimum 300mm safe area around the sides and 1200mm above the product that is clear of obstructions and flammable materials
- Do not place the mains lead beneath a carpet or rug
- Do not use this appliance in locations where paint, petrol or other flammable liquids are used or stored
- Please ensure the appliance is switched off and unplug when not in use.
- Do not use the appliance for other than its intended use.
- Do not insert any object into the appliance through the grilles. This may damage the product or result in overheating or electric shock.
- Only use this product on a flat, stable surface.
- Do not leave this product unattended when in use.
- For domestic use only.
- There are no user serviceable parts in this product.
- Allow to cool down before moving.
- Do not use under curtains or close to soft furnishings.
- Do not leave water in this product for prolonged periods of time
- Do not move or knock this product while in use. Risk of Electrical Shock
- Disconnect the product from the mains before emptying the unit
- This appliance is fitted with an overload cut-out which will operate if the motor overheats or is stalled. If this happens, disconnect from the mains supply immediately and allow the motor to cool down
- Do not use if incorrectly fitted
- Do not obstruct the air intakes and exhaust vents on this appliance.
- Do not cover.
- This product must only be used and transported in an upright position.
- Do not use in areas with high concentrations of dust or fibre particles.
- This unit must be switched off and disconnected from the mains before the tank is emptied or filters cleaned.
- The refrigerant loop is sealed. Only a qualified technician should attempt to service
- No open flames, cigarettes or other possible sources of ignition should be used inside or in the vicinity of the units.

SYMBOLS FROM THE UNIT AND USER MANUAL



warning

This unit uses a flammable refrigerant.
If refrigerant leaks and comes in contact with fire or heating part, there is risk of fire.



Read the USER MANUAL carefully before operation.



Further information is available in the USER MANUAL, SERVICE MANUAL, and the like.



Service personnel are required to carefully read the USER MANUAL and SERVICE MANUAL before operation.



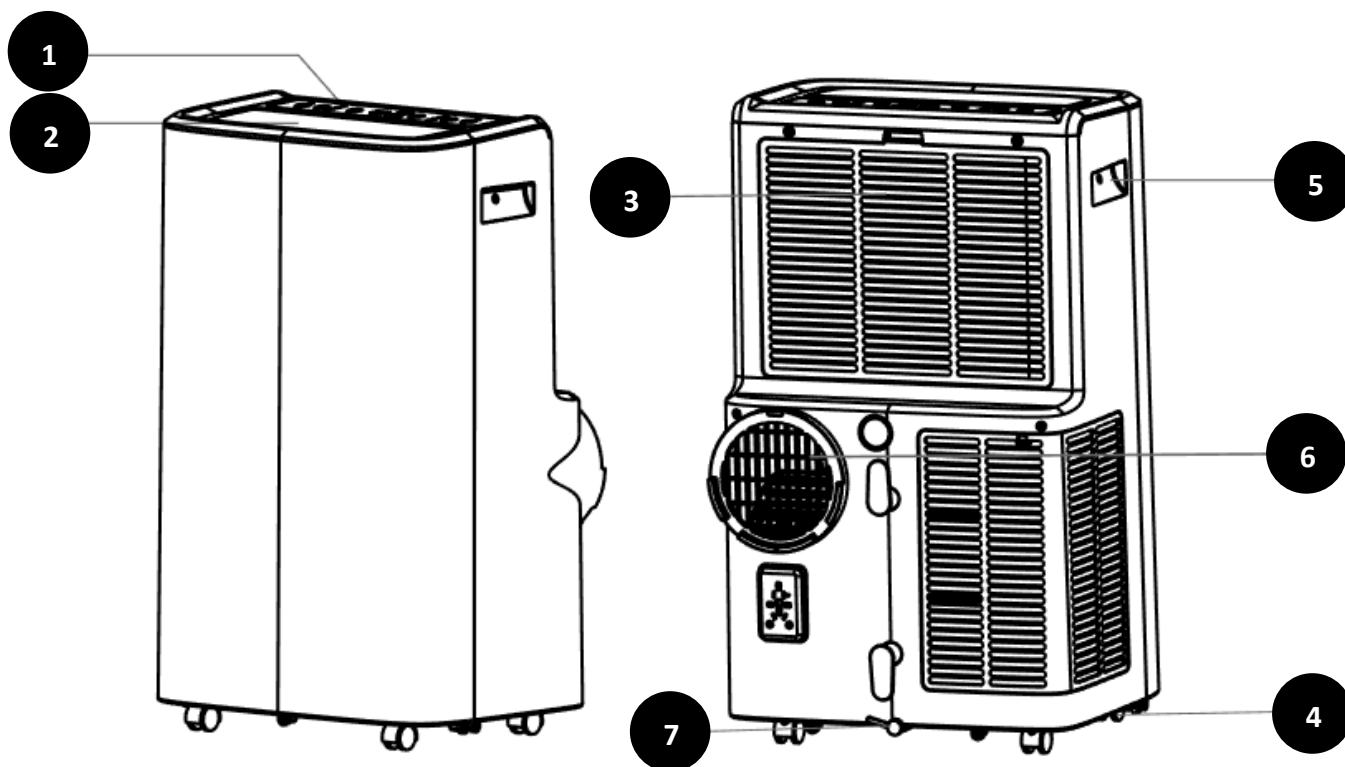

PRODUCT DIAGRAM

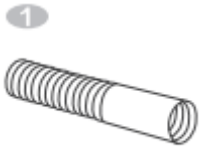

1. Control Panel
2. Air outlet with adjustable Louver
3. Air Inlet with Air Filter
4. Power Cord
5. Recessed Handle
6. Air Exhaust
7. Drain opening with Sealing Plug

Note: the appearance is only for reference, please see the real product for detailed information.

ACCESSORIES

 <p>1</p>	Exhaust Hose
 <p>2</p>	Hose Connector
 <p>3</p>	Window Kit Adaptor
 <p>4</p>	Remote Control
 <p>5</p>	Window Kit

FITTING THE EXHAUST HOSE

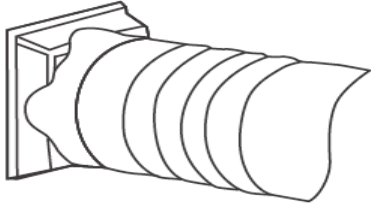
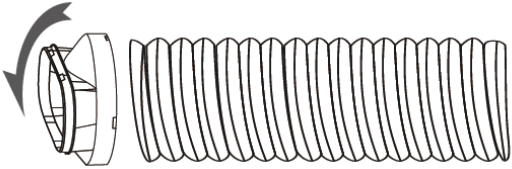
<p>1. Connect the hose connector to one end of the exhaust hose</p>	
<p>2. Connect the windows adaptor kit to the other end of the exhaust hose</p>	

3. Extend the adjustable window kit the length of the window



4. Close your window to secure the kit in place. It needs to hold the window kit firmly in place.

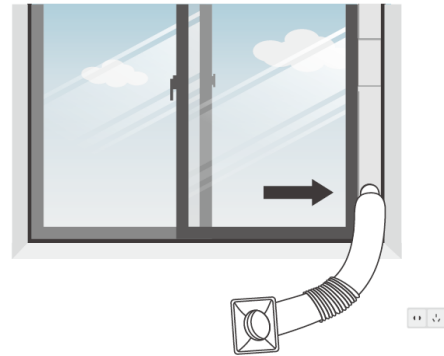

5. Attach the hose connector to the exhaust air outlet of the unit.

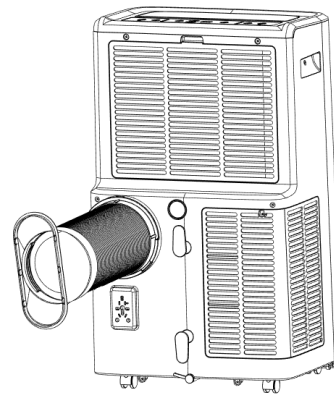

6. Adjusting the length of the flexible exhaust hose, and avoiding bends in the hose, then place the AC in the desired location.

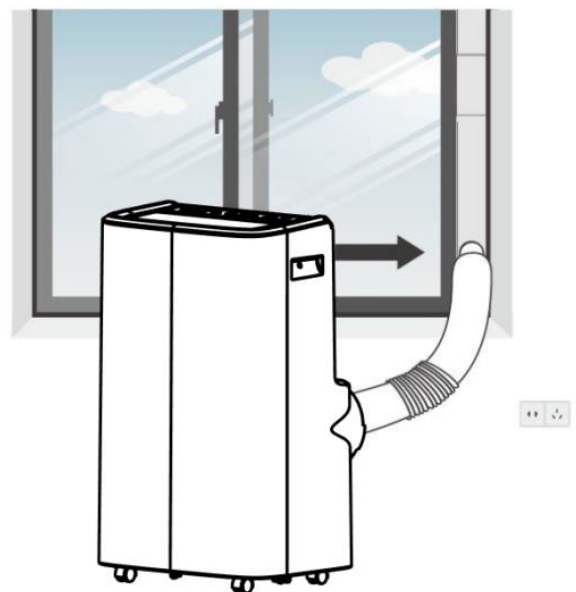

CONTROL PANEL AND DISPLAY

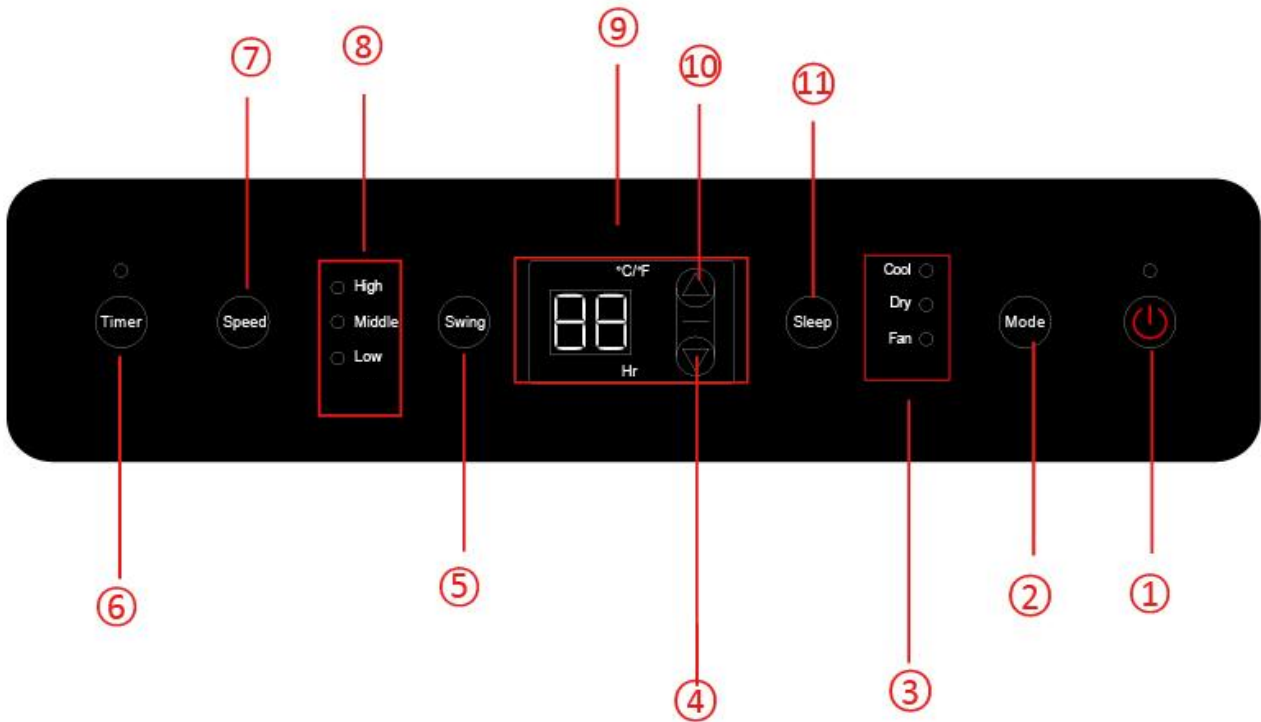

1	Power	Press to switch the machine on or off.
2	Mode	Mode button. Press to switch the operation mode between cool, fan and dry.
3	Indicators	LED for 3 operation modes. Select by pressing mode button.
4	Minus	Decreasing the desired temperature or timer setting.
5	Swing	Adjust the horizontal air flow direction
6	Timer	Sets a time for the unit to automatically start or stop.
7	Fan Speed	Press to switch the fan speed between High, Low and Medium
8	Indicators	LED for fan speed (High/Medium/Low)
9	Digital Display	Displays timer setting and room temperature.
10	Add	Increasing the desired temperature (16°C ~ 32°C) or timer setting.
11	Sleep	Press to turn sleep mode on or off.

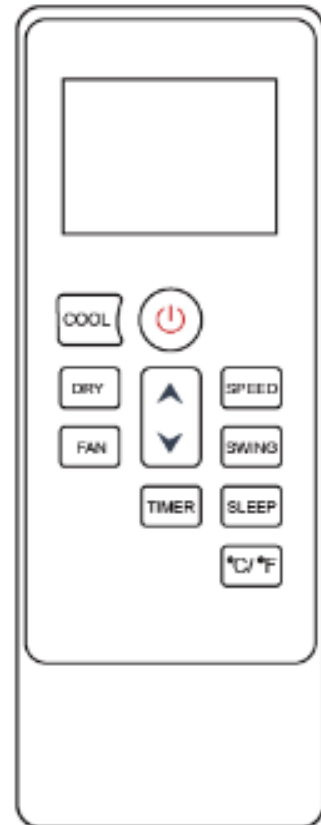

Remote Control Panel

OPERATION

The unit has 4 operating modes: Cool, Fan, Dry, Sleep

1. Start up and Shutdown

- 1.1. Press POWER to turn the unit on (the unit runs in FAN mode as default)
- 1.2. Press MODE button to select the desired operating mode
- 1.3. Press POWER again to turn off

Caution!: The unit must only be shut down using the control panel or remote control, never directly unplug the unit from the mains as this can seriously damage the unit and increase the risk of fire

2. Cooling Mode

- 2.1. Press MODE button until the COOL LED is illuminated
- 2.2. Use ADD and MINUS buttons to adjust the temperature which is displayed on the screen. The temperature can be set between 16°C and 32°C
- 2.3. Press SPEED button to adjust the fan speed
- 2.4. To control the direction of the air flow, Press the SWING button.

Note: The air conditioner stops if the room temperature is equal to the selected temperature

3. Ventilating your room

- 3.1. Press MODE button until the FAN LED is illuminated
- 3.2. Press SPEED button to adjust the fan speed

Note: in ventilation mode the room air is circulated, but not cooled

4. Drying your Room

- 4.1. Press MODE button until the DRY LED is illuminated
- 4.2. In this mode the fan speed cannot be adjusted
- 4.3. It is recommended that the user connects the hose to the drain outlet on the bottom of the unit

5. Sleep Mode

- 5.1. Press the sleep button on the remote control – after one hour the preset temperature is increased by 1°C. this increases after another hour until the current room temperature is achieved.

TIMER SETTING

The timer can be used for 2 operations: Delay start and Delay stop

1. Delay Start
 - 1.1. When the unit is turned off, press the TIMER key to turn on timer function
 - 1.2. Use the ADD and MINUS buttons to set the timer value
 - 1.3. The unit will switch on after the set number of hours
2. Delay Stop
 - 2.1. When the unit is switched on, press the TIMER key to turn on the timer function
 - 2.2. Use the ADD and MINUS buttons to set the timer value
 - 2.3. The unit will switch off after the set number of hours
3. To cancel the timer, use the ADD and MINUS buttons to set the timer value to "00"

AUTOMATIC DEFROST

At low room temperatures, frost may build up at the evaporator during operation. The unit will automatically start defrosting and the POWER LED will blink. The defrost control sequence is as follows: When the unit is operating in cooling or drying mode, and the evaporator coil temperature is below -1°C , the compressor will stop operating for 10 minutes until the coil temperature is up to 7°C – the unit will then restart to cool operating mode.

OVERLOAD PROTECTION

In the event of a power loss, to protect the compressor, there is a 3-minute delay until the compressor restarts.

DRAINAGE

The self-evaporating system uses the collected water to cool the condenser coils for better efficient performance. There is no need to empty the drainage tank in cooling operation except in exceptionally high humidity conditions. The condensate water evaporates at the condenser and is evacuated through the exhaust hose.

For continuous operation in drying mode, please connect the attached drain hose to the unit. Condensate water can then be directly drained into a bucket or similar.

Switch off the unit before this operation	
Remove the plug of the water outlet opening and keep it in a safe place	
Securely and properly connect the drain hose and ensure it is not kinked and is clear of obstruction	

Place the outlet of hose over a drain or a bucket and ensure that water can flow freely out of the unit

Do not submerge the end of the hose into water, as this can cause an "air lock" in the hose

To avoid water spillage, tilt the drain hose down towards the floor and straighten out any kinks in the hose

Note: Remember to replace the plug after using the drain hose!



CLEANING AND CARE

Cleaning the Air Filter

Dust collects on the air filter and restricts the airflow. The restricted airflow reduces the efficiency of the system and if it becomes blocked it can cause damage to the unit.

The air filter requires regular cleaning. The air filter is removable for easy cleaning. **DO NOT OPERATE** the unit without the air filter or the evaporator may become contaminated.

1. Press **POWER** button to switch off the unit, then unplug the unit from the mains
2. Remove the filter mesh from the back of the unit
3. Use a vacuum cleaner to suck dust from the filter
4. Turn the filter over and rinse the air filter under running water. Let the water run through the filter in the opposite direction of air flow. Set aside and allow the filter to air dry before reinstalling.

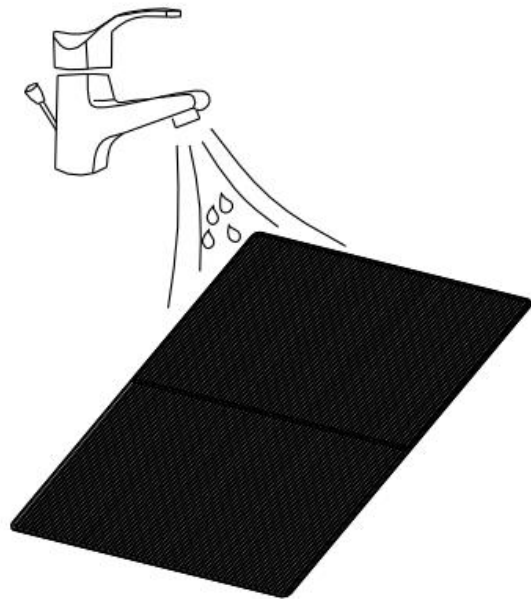

WARNING! To prevent accidental injury from extreme temperatures and sharp edges, do not touch the evaporator surface!

STORAGE

For long term storage (more than a few weeks) it is best to clean the unit and dry it out completely:

1. Unplug the unit and remove exhaust hose and window kit.
2. Drain the remaining water from the unit
3. Clean the filter and let the filter dry completely
4. Collect the power cord at the water tank
5. Re-install the filter in its position
6. The unit must be kept in upright position when in storage
7. To preserve the unit, keep in a dry, well ventilated space indoors.

Note: the evaporator has to be completely dried out to avoid component damage and mould. Unplug the unit and leave in a dry open area for a few days to completely dry it out.

TROUBLESHOOTING

Symptom		Inspection	Solution
The unit is not operating.		✓ Check the power connection in securely.	➤ Insert the power cord securely into the wall Outlet.
		✓ Check if the water level indicator lights up?	➤ Empty the drain pan by remove the rubber plug.
		✓ Check the room temperature.	➤ The range of operating temperature is 5-35°C.
The unit works with reduced capacity.		✓ Check the air filter for dirt.	➤ Clean the air filter as necessary.
		✓ Check if the air duct is blocked.	➤ To clear the obstacle.
		✓ Check if the room door or window is open.	➤ Keep the door and windows closed.
		✓ Check if the desired operating mode is selected and the temperature is properly set.	➤ Set the mode and temperature at proper set-point according the manual.
		✓ The exhaust hose is detached.	➤ Make sure the exhaust hose is securely attached.
Water Leakage		✓ Overflow while moving the unit.	➤ Empty the water tank before transport.
		✓ Check if the drain hose is kinked or bends.	➤ Straighten the hose to avoid a trap existing.
Excessive Noise		✓ Check if the unit is securely positioned.	➤ Place the unit on horizontal and firm ground.
		✓ Check if any loose, vibrating parts.	➤ Secure and tight the parts.
		✓ Noise sounds like water flowing.	➤ Noise comes from flowing refrigerant. This is normal.
Error Codes	E0	✓ Communication faults between main PCB and display PCB.	➤ Check the wire harness of the display PCB for damage.
	E1	✓ Ambient temperature sensor failure	➤ Check connection or replace it. To clean or replace the temperature sensor.
	E2	✓ Coil temperature sensor failures.	➤ Check connection or replace it. To clean or replace the temperature sensor.
	Ft	✓ Condensate water high level alarm.	➤ Empty the drain pan by removal the rubber plug.

GENERAL SAFETY REQUIREMENTS

Domestic wiring must be tested periodically by a qualified electrician at least once every 10 years or at every change of occupancy. For office and retail premises, and buildings such as village halls, the wiring must be inspected at least once every 5 years. It is recommended that all buildings be fitted with smoke alarms (it is mandatory for new buildings).

TESTING

When used in an office environment, we recommend that this product should be safety-tested yearly by a qualified electrician (PAT Tested).

We recommend that it is PAT tested regularly when used in a domestic environment.

If the mains lead is damaged, it must be replaced by the manufacturer or an authorised service centre. If the mains plug needs to be replaced, proceed as follows:

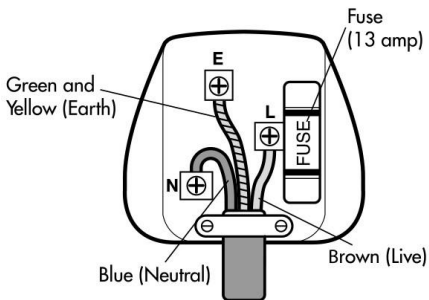

- Connect the brown wire to the terminal labelled “L”
- Connect the blue wire to the terminal labelled “N”
- Connect the green and yellow wire to the upper terminal labelled “E”
- Make sure that the cord-grip is positioned correctly (over the outer sheath of the cable) and it fully tightened.
- If the plug is fitted with a fuse other than 13A, then please replace with an approved fuse of the correct value.

OPERATING COSTS

At time of going to press, the average cost of electricity is £0.15 per unit (kilowatt-hour). The amount you are being charged will be shown on your electricity bill. At this cost, the EH1924 will cost £4.80 per day to run on the “High Speed” setting.

DISPOSAL AND RECYCLING

You must not dispose of this appliance with domestic household waste.

Most local authorities have specific collection system for appliances and disposal is free of charge to the end-user. When replacing an existing appliance with a similar new appliance your retailer may take the old appliance for disposal.

TECHNICAL SPECIFICATION

Product Code	EH1924
Cooling Capacity (Btu/h)	12,000
Power Supply	230V~
Rated Cooling Input (W)	1337
Rated Current Cooling (A)	5.9
EER For Cooling (W/W)	2.63
Noise Level (dB) (High)	65
Product Dimensions (mm)	762 x 470 x 353
Packaging Dimensions (mm)	878 x 462 x 505
Refrigerant (Type/Charge)	R290/240g
Net Weight (kg)	29.5
Gross Weight (kg)	33.5
Application Area (m ²)	18-25
Fan Speeds	3
Louvres	Automatic

Prem-i-Air guarantees the product free from defects in materials and workmanship for a period of twelve months. Should this appliance be operated under conditions other than those recommended, at voltages other than the voltage indicated on the appliance, or any attempts made to service or modify the appliance, then the warranty will be rendered void. The product you buy may sometimes differ slightly from illustrations. This warranty is in addition to, and does not affect, your statutory rights. Our guarantee is administered by our retailers.

If your product arrives damaged, you must contact the retailer from whom you bought it. The retailer's contact details will be on the invoice that arrived with the product, or on the e-mail you received when you placed the order. Do not contact Prem-i-air, only your retailer can arrange a replacement. If your product fails within the guarantee period, firstly read the "fault finding" section of this manual, because temperature and weather conditions can affect the performance of certain products.

If the product needs to be repaired or replaced, you must contact the retailer from whom you bought it. The retailer's contact details will be on the invoice that arrived with the product, or on the e-mail you received when you placed the order. If you have just received your product and require technical help in using it, please call our Help Desk on (0845) 459 4816. If you have any other technical queries about the product, please call our Help Desk on (0845) 459 4816.

Prem-i-Air Appliances Ltd.,
Lancots Lane, Sutton,
St. Helens, Merseyside.
WA9 3EX
www.prem-i-air.com